

 **SAMPLING
SYSTEMS**
OVER ONE MILLION STOCK ITEMS



Laboratory | Production | Quality

 **SteriWare**
Ultra

 **SteriWare**

 **AccuPod**

 **Metal** Detectable

 **StainlessWare**

 **FreeGlide**
The only In-Line Plastic Sample Grabber not to get stuck

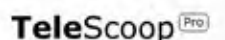
 **TeleScoop** Pro

Welcome to the latest edition of our Range Brochure

This brochure contains over 250 innovative new products. Many of these new products have been inspired by queries and comments from our customers. Please do not hesitate to contact us if you can not find what you are looking for.

SteriWare ULTRA Range

SteriWare ULTRA is a range of high quality, single use products for very demanding applications. These products are all double bagged and are made with polymers that conform to the latest standard (USP Class VI, FDA and EU). See pages 12 to 47.

Metal Detectable Range

Another new range is our Metal Detectable Range. We have a wide range of products manufactured from a special food grade metal detectable polymer. The polymer is not only metal detectable but is also visible to x-rays. See pages 133 to 138.

Over 250 NEW Products

In addition to introducing several completely new product ranges we have also added many new products to existing ranges.

Huge Stocks for Fast Deliveries

We hold well over 95% of our range in stock for immediate world-wide shipping.

We hope that you find what you require but if you have any queries, please do not hesitate to contact our friendly sales team.

Jonathan Fenner



Simon Fenner



To Lab



To Production

From the initial design to the final stages of manufacturing, we immerse ourselves in the entire process of developing our products. This ensures that our high standards of quality and efficiency are maintained, while allowing us complete control over every detail from prototype to the final delivery.

Implementing the latest design techniques and cutting edge manufacturing technology, we offer a diverse and comprehensive range of sampling equipment, available to order from stock.

New Products



Mini-Pots



Needle

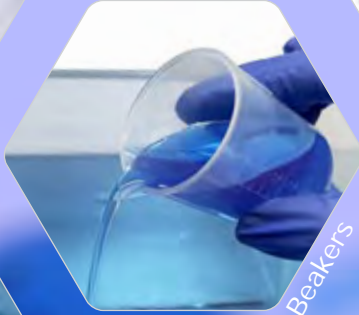

Graduated Beakers



Sterile Bottle



Cleaning Coupons



TeleScoop Pro

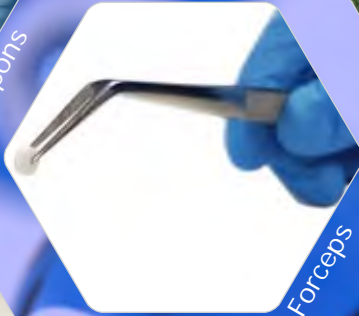

Angled Forceps



Multi-grip Tweezers



Sack Master



GMP Scoop PS



Slot Sampler



Powered Ice Sampler



SteriWare® Powder Thief



Cake Sampler



Utility Dipper



Pump Sampler



Stainless Containers



Label Dispensers

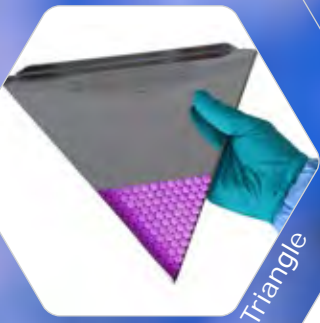

Triangle
Tablet



Buckets (316Lss)



Ladle
SteriWare®



Soil Sampler
Pro



Sub Sampler
Pro



Spoon
Chemical



Spoon
Dosing



Filling Scoop (316L ss)



Bottle GL45
Stainless



Hand Paddle
With Holes



Swabbing
Templates



Metal
Detectable



Jacketed
Containers



Rounded
Scissors



PeriPump



Flask Tongs



GMP Pallet
Knives



Swabbing
Kits

Over 250 New Products

contents

Disposables

Pages 7 to 50



Powder Samplers

Pages 51 to 88



Liquid Samplers

Pages 89 to 110



Semi Solid Samplers

Pages 111 to 118



Environmental Sampling

Pages 119 to 132



Metal Detectable

Pages 133 to 138



Accessories

Pages 139 to 178



Labels

Pages 179 to 186



Bottles & Containers

Pages 187 to 210



Disposables



SteriWare®

The SteriWare Difference



Standard Features



Cleanroom Manufacture

Fast delivery worldwide



100% Inspection

Individually Bagged

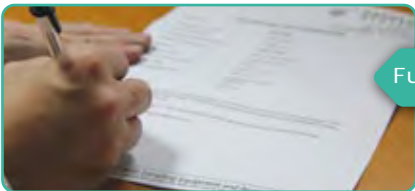
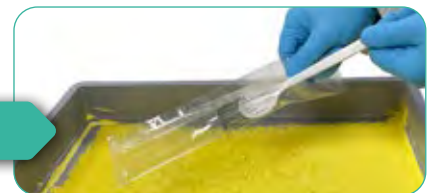

Full Documentation & Traceability

Sterility Assurance



Over one million stock items

Validated Sterilisation



* Please see the specifications sheets for confirmation

The Ultra Difference



Introducing the ULTRA Range

Sampling Systems are proud to introduce the new ULTRA Range. This range is perfect for the more demanding applications.

We have taken all the standard benefits of SteriWare and added the following extra features:

Extra Features of SteriWare Ultra

Made from HDPE which conforms to:

- USP Class VI
- USP 661.1
- FDA 21 CFR 177.1520
- EC 1935/2004
- EU 10/2011
- BSE/TSE Free

USP Class VI

USP Class VI

Double Bagged

- Every item is double bagged
- Parts are carefully put into an additional bag that lines the box
- Gamma detection dot on every inner bag indicates that the products have been irradiated

Double Bagged

SteriWare PharmaScoop®

The Industry Standard - High Quality, Single Use Powder Scoops

The Sampling Systems range of disposable PharmaScoops® have been specially designed for dispensaries and manufacturing. They are the ultimate in quality and affordability.

SteriWare® PharmaScoops® are used by pharmaceutical, food and industrial companies all over the world.

- Manufactured and packed in a Cleanroom
- Individually Bagged in ultra strong packing with easy opening design
- Made from FDA, EC 1935/2004 & EU 10/2011 Conforming Materials
- BSE/TSE Free
- Full Batch Traceability
- Available sterile (SAL 10⁻⁶) and non-sterile from stock



The GMP PharmaScoop

It is Good Manufacturing Practice to keep your hands out of the product as much as possible. In accordance with this we have positioned the ergonomic handles high up on the scoop.

The Biggest Choice - Make sure you have the right scoop



Don't forget your scoop!
A brightly coloured scoop can be easily seen.

The Correct Material and Colour

We have the widest choice of materials and colours available:

PS - great for most applications. Strong and tough

HDPE and PP - extra levels of chemical resistance

Coloured scoops give increased visibility.

Wide Range of Sizes and Shapes

We know that not just one shape fits all applications so we have a wide range of styles and sizes so you can have the best scoop for your process.

Chemical Resistance Chart

See page 213.
Many commonly used chemicals are listed in our easy to use reference chart.

What Polymers are used in SteriWare products?

Abbreviation	Name	Approximate Working Temperature
HDPE	High Density Polyethylene	-50°C to +110°C
LDPE	Low Density Polyethylene	-50°C to +85°C
PP	Polypropylene	-0°C to +130°C
PS	Polystyrene (HIPS - High Impact Polystyrene)	-20°C to +80°C

Notes:

1. In this brochure PS and HIPS are used interchangeably. HIPS is used for most SteriWare products.
2. Working temperatures are approximate values only.

**New
sizes**

White PharmaScoop PS

Best Seller

Volume 30ml to 2500ml

Part No.	Nominal Capacity	Sterile	Box Quantity
8045A-30	30ml	No	100
8045A-30S	30ml	Yes	100
8045A-60	60ml	No	100
8045A-60S	60ml	Yes	100
8045A-125	125ml	No	100
8045A-125S	125ml	Yes	100
8045A-250	250ml	No	85
8045A-250S	250ml	Yes	85
8045A-500	500ml	No	50
8045A-500S	500ml	Yes	50
8045A-1000	1000ml	No	25
8045A-1000S	1000ml	Yes	25
8045A-2500	2500ml	No	15
8045A-2500S	2500ml	Yes	15



- ✓ Made from Polystyrene (PS)
- ✓ FDA and EC conforming
- ✓ BSE/TSE free
- ✓ Individually Bagged
- ✓ Made and packed in a Cleanroom

PharmaScoop HDPE

Extra Chemical Resistance

Volume 30ml to 2500ml

Part No.	Nominal Capacity	Sterile	Box Quantity
8045H-30	30ml	No	100
8045H-60	60ml	No	100
8045H-60S	60ml	Yes	100
8045H-125	125ml	No	100
8045H-125S	125ml	Yes	100
8045H-250	250ml	No	85
8045H-250S	250ml	Yes	85
8045H-500	500ml	No	50
8045H-500S	500ml	Yes	50
8045H-1000	1000ml	No	25
8045H-1000S	1000ml	Yes	25
8045H-2500S	2500ml	Yes	15



- ✓ Made from HDPE
- ✓ FDA and EC conforming
- ✓ BSE/TSE free
- ✓ Individually Bagged
- ✓ Made and packed in a Cleanroom

PharmaScoop PP

Great Chemical Resistance

Volume 30ml to 2500ml

Part No.	Nominal Capacity	Sterile	Box Quantity
8045P-30	30ml	No	100
8045P-30S	30ml	Yes	100
8045P-60	60ml	No	100
8045P-60S	60ml	Yes	100
8045P-125	125ml	No	100
8045P-125S	125ml	Yes	100
8045P-250	250ml	No	85
8045P-250S	250ml	Yes	85
8045P-500	500ml	No	50
8045P-500S	500ml	Yes	50
8045P-1000	1000ml	No	25
8045P-1000S	1000ml	Yes	25
8045P-2500	2500ml	No	15
8045P-2500S	2500ml	Yes	15



- ✓ Made from Polypropylene (PP)
- ✓ FDA and EC conforming
- ✓ BSE/TSE free
- ✓ Individually Bagged
- ✓ Made and packed in a Cleanroom

Disposables

Red PharmaScoop PS

Highly Visible

Volume 30ml to 2500ml

Part No.	Nominal Capacity	Sterile	Box Quantity
8045R-30	30ml	No	100
8045R-30S	30ml	Yes	100
8045R-60	60ml	No	100
8045R-60S	60ml	Yes	100
8045R-125	125ml	No	100
8045R-125S	125ml	Yes	100
8045R-250	250ml	No	85
8045R-250S	250ml	Yes	85
8045R-500	500ml	No	50
8045R-500S	500ml	Yes	50
8045R-1000	1000ml	No	25
8045R-1000S	1000ml	Yes	25
8045R-2500	2500ml	No	15
8045R-2500S	2500ml	Yes	15



- ✓ Made from Polystyrene (PS)
- ✓ FDA and EC conforming
- ✓ BSE/TSE free
- ✓ Individually Bagged
- ✓ Made and packed in a Cleanroom

Blue PharmaScoop PP

Highly Visible with High Chemical Resistance

Volume 60ml to 2500ml

Part No.	Nominal Capacity	Sterile	Box Quantity
8045B-60	60ml	No	100
8045B-60S	60ml	Yes	100
8045B-125	125ml	No	100
8045B-125S	125ml	Yes	100
8045B-250	250ml	No	85
8045B-250S	250ml	Yes	85
8045B-500	500ml	No	50
8045B-500S	500ml	Yes	50
8045B-1000	1000ml	No	25
8045B-1000S	1000ml	Yes	25
8045B-2500	2500ml	No	15
8045B-2500S	2500ml	Yes	15



- ✓ Made from Polypropylene (PP)
- ✓ FDA and EC conforming
- ✓ BSE/TSE free
- ✓ Individually Bagged
- ✓ Made and packed in a Cleanroom

ULTRA PharmaScoop

USP Class VI - Double Bagged

- ✓ Made from HDPE - USP Class VI
- ✓ USP Class 661, FDA and EC conforming
- ✓ BSE/TSE free
- ✓ Double Bagged
- ✓ Made and packed in a Cleanroom



Part No.	Nominal Capacity	Sterile	Box Quantity
9045H-125S	125ml	Yes	50
9045H-250S	250ml	Yes	25
9045H-1000S	1000ml	Yes	10

Other sizes available on request

GMP Volumetric Scoop PS

Ergonomic Flat Scoop

Volume 25ml to 1000ml



Part No.	Nominal Capacity	Sterile	Box Quantity
8286A-25	25ml	No	100
8286A-25S	25ml	Yes	100
8286A-50	50ml	No	100
8286A-50S	50ml	Yes	100
8286A-100	100ml	No	100
8286A-100S	100ml	Yes	100
8286A-150	150ml	No	100
8286A-150S	150ml	Yes	100
8286A-250	250ml	No	100
8286A-250S	250ml	Yes	100
8286A-500	500ml	No	40
8286A-500S	500ml	Yes	40
8286A-1000	1000ml	No	30
8286A-1000S	1000ml	Yes	30



- ✓ Free-standing scoop with flat base
- ✓ Made from Polystyrene (PS)
- ✓ FDA and EC conforming
- ✓ BSE/TSE free
- ✓ Individually Bagged
- ✓ Made and packed in a Cleanroom

GMP Sample Scoop With Lid PS

Secures the Sample in the Scoop

Volume 25ml to 100ml



Part No.	Nominal Capacity	Sterile	Box Quantity
8916A-25	25ml	No	50
8916A-25S	25ml	Yes	50
8916A-50	50ml	No	50
8916A-50S	50ml	Yes	50
8916A-100	100ml	No	50
8916A-100S	100ml	Yes	50



- ✓ Click-on see through lid allows you to see sample
- ✓ Made from Polystyrene (PS)
- ✓ FDA and EC conforming
- ✓ BSE/TSE free
- ✓ Individually Bagged
- ✓ Made and packed in a Cleanroom

Disposables

ULTRA Volumetric Scoop

USP Class VI - Double Bagged

Volume 25ml to 1000ml

USP Class VI Double Bagged



- ✓ Made from HDPE - USP Class VI
- ✓ USP Class 661, FDA and EC conforming
- ✓ BSE/TSE free
- ✓ Double Bagged
- ✓ Made and packed in a Cleanroom

Part No.	Nominal Capacity	Sterile	Box Quantity
9286H-25S	25ml	Yes	50
9286H-50S	50ml	Yes	50
9286H-100S	100ml	Yes	50
9286H-150S	150ml	Yes	50
9286H-250S	250ml	Yes	25
9286H-500S	500ml	Yes	20
9286H-1000S	1000ml	Yes	20



SteriWare® Long Handled Scoop

Keep hands away from the product

SteriWare Long Handled Scoops are the ideal tool for reaching into deep containers. The extra long 300mm handle will help operators keep their hands out of the product.

The long handle makes the scoop more visible if it is left in the powder. The red version helps this even further.

Both non-sterile and sterile scoops are available from stock. They are manufactured in a Cleanroom to ensure cleanliness and reduce particulate contamination.

- Manufactured and packed in a Cleanroom
- Individually Bagged
- Made from FDA, EC 1935/2004 & EU 10/2011 conforming HDPE
- BSE/TSE Free
- Available in uncoloured natural HDPE or bright red HDPE
- Full Batch Traceability
- Available sterile (SAL 10⁻⁶) and non-sterile

Volume 25ml to 100ml



New sizes

HDPE - Natural

Part No.	Nominal Scoop Volume	Sterile	Box Quantity
8341H-25	25ml	No	50
8341H-25S	25ml	Yes	50
8341H-50	50ml	No	50
8341H-50S	50ml	Yes	50
8341H-100	100ml	No	50
8341H-100S	100ml	Yes	50



New

HDPE - Red

Part No.	Nominal Scoop Volume	Sterile	Box Quantity
8341R-50S	50ml	Yes	50
8341R-100S	100ml	Yes	50



SteriWare® Well Packed

All our SteriWare products are packed into high quality boxes for safe storage and transportation.

It is our priority that your SteriWare products will arrive quickly, safely and in good condition.

See the difference with SteriWare.

SteriWare® Counting Triangle

The quick and easy way to count round tablets

The SteriWare Counting Triangle is ideal for counting round tablets. They are manufactured and packed in a Cleanroom and can be used straight from the bag.

- Suitable for left handed and right handed operators
- Individually bagged
- Made from FDA, EC 1935/2004 & EU 10/2011 conforming PS
- Manufactured and packed in a Cleanroom
- Available from stock for fast delivery worldwide

Part No.	Side length	Height	Sterile	Material	Box Quantity
8066A-1	230mm	13mm	No	PS	30
8066A-1S	230mm	13mm	Yes	PS	30



SteriWare® Capsule Counting Trays

Use straight from the bag

The disposable counting trays are made from robust, shatter-proof PS. They are suitable for use with all capsules from Size 2 to Size 00.

- Individually bagged
- FDA and EU 10/2011 conforming material
- Manufactured and packed in a Cleanroom
- Available from stock for fast delivery worldwide
- Available sterile (SAL 10⁻⁶) and non-sterile

Part No.	Length	Width	Sterile	Material	Box Quantity
8444A-1	260mm	130mm	No	PS	20
8444A-1S	260mm	130mm	Yes	PS	20



Disposables

SteriWare® Tray

High quality tray made in a Cleanroom

The disposable Tray is ideal for hygienic applications within hospitals and pharmaceutical factories.

- Manufactured and packed in a Cleanroom
- Individually Bagged
- Made from FDA, EC 1935/2004 & EU 10/2011 conforming PP
- BSE/TSE Free
- Full Batch Traceability
- Available sterile (SAL 10⁻⁶) and non-sterile



Part No.	Dimensions (L x W x H)	Nominal Volume	Sterile	Material	Box Quantity
8081P-3000	318 x 267 x 55mm	3000ml	No	PP	40
8081P-3000S	318 x 267 x 55mm	3000ml	Yes	PP	30

SteriWare® Powder Bottle

Individually Bagged Bottles Made in a Cleanroom

SteriWare Powder Bottles are a premium screw top bottle from Sampling Systems. They are designed to meet the requirements of the pharmaceutical and hygienic industries.

Powder Bottles are made and packed in our Cleanroom. The bottles have a wide opening and so are ideal when working with powders and granules.

- Powder-tight
- Available in 250ml and 500ml sizes
- Manufactured & Packed in a Cleanroom
- Individually Bagged
- Made from FDA, EC 1935/2004 & EU 10/2011 conforming PP
- BSE/TSE Free
- Full Batch Traceability
- Available sterile (SAL 10⁻⁶) and non-sterile

Volume 250ml to 500ml



Polypropylene (PP) - Natural

Part No.	Nominal Volume	Sterile	Overall Height	Outer Diameter	Box Quantity
8890P-250	250ml	No	88mm	76mm	50
8890P-250S	250ml	Yes	88mm	76mm	50
8890P-500	500ml	No	106mm	94mm	37
8890P-500S	500ml	Yes	106mm	94mm	37



Sterile Liquid & Powder Bottle

Individually Bagged Sterile Bottles

Volume 60ml to 2000ml

The perfect bottle for use in laboratory and production. The wide mouth makes these bottles suitable for use with both powders and liquids.

Every bottle is individually wrapped in a robust laminate bag. After packing they are sterilised using gamma irradiation.

Simply unwrap and use.

- Non leak (Powder-tight and water-tight)
- Packed in a Cleanroom
- Individually Bagged
- Made from FDA, EC 1935/2004 & EU 10/2011 conforming HDPE and PP
- BSE/TSE Free

New sizes

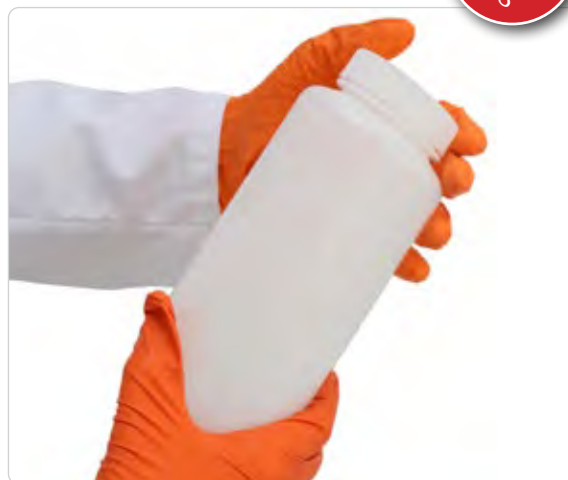

Part No.	Nominal Volume	Sterile	Material	Box Quantity
8404H-60S	60ml	Yes	HDPE body & PP lid	50
8404H-125S	125ml	Yes	HDPE body & PP lid	50
8404H-250S	250ml	Yes	HDPE body & PP lid	50
8404H-500S	500ml	Yes	HDPE body & PP lid	30
8404H-1000S	1000ml	Yes	HDPE body & PP lid	30
8404H-2000S	2000ml	Yes	HDPE body & PP lid	10



SteriWare® Bowls

Ideal for handling and mixing Powders and Liquids

Volume 500ml to 3000ml

Disposable Bowls are ideal for pre-mixing potent drugs and highly coloured substances prior to blending. They are manufactured from food grade HDPE.

Both sizes of SteriWare Bowls have side handles. The 500ml bowls have a pouring spout.

- Manufactured and packed in a Cleanroom
- Individually Bagged
- Made from FDA, EC 1935/2004 & EU 10/2011 conforming HDPE
- BSE/TSE Free
- Full Batch Traceability
- Available sterile (SAL 10⁻⁶) and non-sterile



SteriWare®
500ml Bowl



3000ml Bowl

Part No.	Nominal Volume	Sterile	Pouring Spout	Bowl Diameter	Height	Material	Box Quantity
8017H-05	500ml	No	Yes	129mm	70mm	HDPE	100
8017H-05S	500ml	Yes	Yes	129mm	70mm	HDPE	100
8017H-30	3000ml	No	No	227mm	109mm	HDPE	15
8017H-30S	3000ml	Yes	No	227mm	109mm	HDPE	15

SteriWare®

Huge Savings and Benefits

Quality

- Cross-contamination risk is eliminated - the device can be used straight from the bag
- No cleaning is required before or after sampling
- No cleaning validation (this is very expensive to set up and run)
- Most devices are manufactured in a Cleanroom environment (check individual sampler descriptions and specifications)
- Suitable for all industries (pharmaceutical, food, chemical, cosmetic, biotechnology etc.)

Financial

- Save time and money (it will cost more to clean a reusable sampler than to buy a disposable sampler)

Speed

- SteriWare products can be used straight from the bag



Spoons



Disposables



The Correct Material and Colour

Made from the widest choice of materials available.

PS - great for most applications. Strong and tough.

HDPE and PP - extra levels of chemical resistance.

Coloured spoons - ideal when you are concerned that the spoon might be left in the powder.

Wide Range of Sizes and Shapes

One shape of spoon will not suit all applications. We offer a huge range of spoon styles, sizes and colours so that you can have the best spoon for your application.

Still Not Sure?

Try before you buy. Contact us for a free sample.

SteriWare® Mini Spoon

Small Economical, Double Ended Spoon

Volume 2.5ml & 5ml

Mini Spoons are a low cost, single use spoon. They allow the quick and efficient surface sampling of powders and granules. Alternatively they can be also used for dispensing small quantities.

- Double ended spoon
- Manufactured and packed in a Cleanroom
- Individually Bagged
- Made from FDA, EC 1935/2004 & EU 10/2011 conforming polystyrene
- BSE/TSE Free
- Full Batch Traceability
- Sterilised by Gamma Irradiation (SAL 10⁻⁶)



Part No.	Volume	Sterile	Box Quantity
8642A-01	2.5ml and 5ml	No	130
8642A-01S	2.5ml and 5ml	Yes	130

SteriWare® Sample Spoons

Ideal for dispensing and sampling small quantities

Volume 3ml to 10ml

Sample Spoons are a high quality, low cost, single use spoon. They are suitable for surface sampling and for general laboratory use.

- Manufactured and packed in a Cleanroom
- Individually Bagged
- Made from FDA, EC 1935/2004 & EU 10/2011 conforming polymers
- BSE/TSE Free
- Full Batch Traceability
- Available sterile (SAL 10⁻⁶) and non-sterile



Polystyrene (PS) - WHITE

Part No.	Nominal Spoon Volume	Sterile	Box Quantity
8088A-03	3ml	No	100
8088A-03S	3ml	Yes	100
8088A-10	10ml	No	100
8088A-10S	10ml	Yes	100



Polystyrene (PS) - RED

Part No.	Nominal Spoon Volume	Sterile	Box Quantity
8088R-10S	10ml	Yes	100



Polypropylene (PP) - BLUE

Part No.	Nominal Spoon Volume	Sterile	Box Quantity
8088B-10	10ml	No	100
8088B-10S	10ml	Yes	100



Disposables

ULTRA Spoon HDPE

USP Class VI - Double Bagged

ULTRA Spoons are made and packed within a Cleanroom. They are double bagged and sterilised and so are ideal for more demanding applications.

- ✓ Made from HDPE, USP Class VI
- ✓ USP Class 661, FDA and EC conforming
- ✓ BSE/TSE free
- ✓ Double Bagged
- ✓ Made and packed in a Cleanroom

Part No.	Nominal Spoon Volume	Sterile	Box Quantity
9088H-03S	3ml	Yes	50
9088H-10S	10ml	Yes	50



SteriWare® Long Handled Spoon

With an ergonomic angled handle

Volume 10ml to 20ml



SteriWare Long Handled Spoons are ideal for reaching into large containers or difficult to reach places.

Each spoon has a robust 300mm handle. The bowl is available either with a straight or an offset profile. The offset version aids pouring (for right handed operators).

- Manufactured and packed in a Cleanroom
- Individually Bagged
- Made from FDA, EC 1935/2004 & EU 10/2011 conforming materials
- BSE/TSE Free
- Full Batch Traceability
- Available Sterile (gamma irradiated)
- Made from chemically resistant HDPE
- Available sterile (SAL 10⁻⁶) and non-sterile



STRAIGHT Spoons - HDPE - Natural

Part No.	Nominal Spoon Volume	Sterile	Box Quantity
8209H-10	10ml	No	100
8209H-10S	10ml	Yes	100
8209H-20	20ml	No	100
8209H-20S	20ml	Yes	100



ANGLED Spoons - HDPE - Natural

Part No.	Nominal Spoon Volume	Sterile	Box Quantity
8293H-10	10ml	No	100
8293H-10S	10ml	Yes	100
8293H-20	20ml	No	100
8293H-20S	20ml	Yes	100



SteriWare® Volumetric Spoons

Single use, accurate measuring spoons

Volume 1ml to 30ml

New sizes

Volumetric Spoons allow small volumes to be accurately measured. The Volumetric Spoons are designed to be used straight from the bag.

- Manufactured and packed in a Cleanroom
- Individually Bagged
- Made from FDA, EC 1935/2004 & EU 10/2011 conforming HDPE
- BSE/TSE Free
- Full Batch Traceability
- Available sterile (SAL 10⁻⁶) and non-sterile

Note: Volumetric Spoons are not certified measuring devices. User validation is required. If in doubt please contact us



Part No.	Flat Fill Volume	Sterile	Box Quantity
8640H-01	1ml	No	100
8640H-01S	1ml	Yes	100
8640H-0123S	1.23ml	Yes	100
8640H-0246S	2.46ml	Yes	100
8640H-05	5ml	No	100
8640H-05S	5ml	Yes	100
8640H-10	10ml	No	100
8640H-10S	10ml	Yes	100
8640H-20	20ml	No	100
8640H-20S	20ml	Yes	100
8640H-30	30ml	No	100
8640H-30S	30ml	Yes	100



Disposables



SteriWare® Certified BSE/TSE Free

We only use high quality polymers for our SteriWare products. All of the polymer resins that we use are certified BSE/TSE free.

During manufacturing the SteriWare products do not come into contact with any products or processes that may pose a BSE/TSE risk.

SteriWare® Pallet Knife

Ideal for Production and Laboratory Use

Pallet Knives are an essential tool when working with creams and ointments, they also make very efficient stirrers. The ergonomic handle makes them comfortable to use.

- Manufactured and packed in a Cleanroom
- Individually Bagged
- Made from FDA, EC 1935/2004 & EU 10/2011 conforming polymers
- BSE/TSE Free
- Full Batch Traceability
- Available sterile (SAL 10⁻⁶) and non-sterile

HDPE - Natural

Part No.	Blade Length	Blade Width	Sterile	Box Quantity
8175H-150	150mm	40mm	No	100
8175H-150S	150mm	40mm	Yes	100
8175H-200	200mm	45mm	No	100
8175H-200S	200mm	45mm	Yes	100



SteriWare®

ULTRA Pallet Knife

USP Class VI - Double Bagged

- ✓ Made from HDPE, USP Class VI
- ✓ USP Class 661, FDA and EC conforming
- ✓ BSE/TSE free
- ✓ Double Bagged
- ✓ Made and packed in a Cleanroom

Part No.	Blade Length	Sterile	Box Quantity
9175H-200S	200mm	Yes	40



SteriWare®
Ultra

ULTRA Micro Spatula

USP Class VI - Double Bagged

- ✓ Made from HDPE, USP Class VI
- ✓ USP Class 661, FDA and EC conforming
- ✓ BSE/TSE free
- ✓ Double Bagged
- ✓ Made and packed in a Cleanroom

Part No.	Nominal Volume	Sterile	Box Quantity
9015HV-170S	0.3ml	Yes	50
9015HN-170S	0.5ml	Yes	50
9015H-170S	2ml	Yes	50



SteriWare®
Ultra

SteriWare® Micro-Spatulas

Ideal for handling small quantities of powders & granules

Volume 0.3ml to 2ml

The Disposable Micro-Spatula is ideal for sampling small volumes. Its narrow sampling blade enables samples to be taken from very small containers such as vials.

- Manufactured and packed in a Cleanroom
- Individually Bagged
- Made from FDA, EC 1935/2004 & EU 10/2011 conforming materials
- BSE/TSE Free
- Full Batch Traceability
- Available sterile (SAL 10⁻⁶) and non-sterile
- Different blade widths available from stock. Ideal when working with small vials or narrow necked sample containers

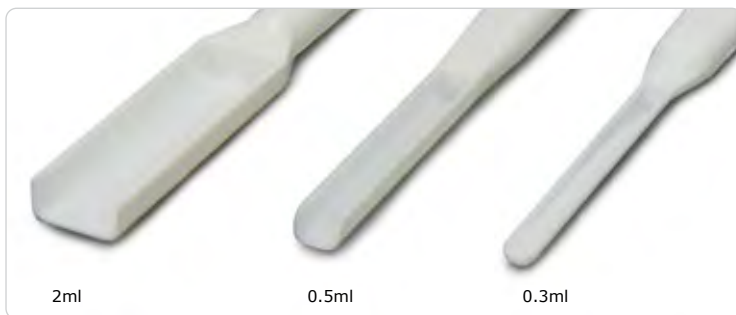

PS (Polystyrene) - WHITE

Part No.	Nominal Volume	Sterile	Blade Width x Length	Length	Box Quantity
8015V-170	0.3ml	No	4 x 40mm	170mm	100
8015V-170S	0.3ml	Yes	4 x 40mm	170mm	100
8015N-170	0.5ml	No	6 x 40mm	170mm	100
8015N-170S	0.5ml	Yes	6 x 40mm	170mm	100
8015A-170	2ml	No	13 x 40mm	170mm	100
8015A-170S	2ml	Yes	13 x 40mm	170mm	100



HDPE - Natural

Part No.	Nominal Volume	Sterile	Blade Width x Length	Length	Box Quantity
8015H-170	2ml	No	13 x 40mm	170mm	100
8015H-170S	2ml	Yes	13 x 40mm	170mm	100



PS (Polystyrene) - RED

Part No.	Nominal Volume	Sterile	Blade Width x Length	Length	Box Quantity
8015VR-170S	0.3ml	Yes	4 x 40mm	170mm	100
8015NR-170S	0.5ml	Yes	6 x 40mm	170mm	100
8015R-170S	2ml	Yes	13 x 40mm	170mm	100



PP (Polypropylene) - BLUE

Part No.	Nominal Volume	Sterile	Blade Width x Length	Length	Box Quantity
8015VB-170S	0.3ml	Yes	4 x 40mm	170mm	100
8015NB-170S	0.5ml	Yes	6 x 40mm	170mm	100
8015B-170S	2ml	Yes	13 x 40mm	170mm	100



Disposables

SteriWare® Scraper

Scraper for powders and pastes

The SteriWare scraper is ideal for use with foodstuffs, cosmetics and pharmaceuticals. The ergonomic design means they are comfortable to use. Ideal for scraping, cleaning and many other uses.

- Manufactured and packed in a Cleanroom
- Individually Bagged
- Made from FDA, EC 1935/2004 & EU 10/2011 conforming HDPE
- BSE/TSE Free
- Full Batch Traceability
- Available sterile (SAL 10⁻⁶) and non-sterile



HDPE - Natural

Part No.	Blade Length	Blade Width	Overall Length	Sterile	Box Quantity
8785H-75	75mm	75mm	190mm	No	100
8785H-75S	75mm	75mm	190mm	Yes	100
8785H-110	110mm	110mm	225mm	No	100
8785H-110S	110mm	110mm	225mm	Yes	100



PP (Polypropylene) - BLUE

Part No.	Blade Length	Blade Width	Overall Length	Sterile	Box Quantity
8785B-75	75mm	75mm	190mm	No	100
8785B-75S	75mm	75mm	190mm	Yes	100



SteriWare® Flat-Spatula or Stirrer

Ideal for stirring, product manipulation and powder handling



The Disposable Flat-Spatula is perfectly designed for a multitude of functions including stirring liquids, manipulation and powder sampling.

- Manufactured and packed in a Cleanroom
- Individually Bagged
- Made from FDA, EC 1935/2004 & EU 10/2011 conforming PS
- BSE/TSE Free
- Full Batch Traceability
- Available sterile (SAL 10⁻⁶) and non-sterile



PS (Polystyrene) - WHITE

Part No.	Sterile	Blade Width x Length	Box Quantity
8729A-170	No	13 x 40mm	100
8729A-170S	Yes	13 x 40mm	100





SteriWare® Multi-Grip Tweezers

Hygienic, dual action Tweezers

SteriWare Multi-Grip Tweezers are robust laboratory forceps. They are designed so that they can easily pick up small items and can be used to securely hold vials.

They are made and packed in a cleanroom and are available sterile or non-sterile.

- Individually bagged
- FDA and EU 10/2011 conforming PS
- Cleanroom manufacture and packing
- Available from stock for fast delivery worldwide
- Available sterile (SAL 10⁻⁶) and non-sterile



Disposables

PS (Polystyrene) - WHITE

Part No.	Length	Sterile	Material	Box Quantity
8270A-200	203mm	No	PS	50
8270A-200S	203mm	Yes	PS	50
8270A-300	303mm	No	PS	50
8270A-300S	303mm	Yes	PS	50

SteriWare® Forceps

Robust Tweezers made in a Cleanroom

SteriWare Forceps are manufactured from polystyrene (PS) and so are very robust. They are manufactured and packed in a Cleanroom and are available sterile or non-sterile.

SteriWare Forceps are ideal when you are working with small items less than 10mm in size.

- Individually bagged
- FDA and EU 10/2011 conforming materials
- Manufactured and packed in a Cleanroom
- Available from stock for fast delivery worldwide
- Available sterile (SAL 10⁻⁶) and non-sterile



PS (Polystyrene) - WHITE

Part No.	Length	Sterile	Material	Box Quantity
8630A-115	115mm	No	PS	100
8630A-115S	115mm	Yes	PS	100



SteriWare® Graduated Beakers

Individually wrapped laboratory beakers

Volume 25ml to 2000ml



SteriWare Graduated Beakers are perfect for measuring, decanting and general laboratory work.

- Manufactured and packed in a Cleanroom
- Individually Bagged
- Graduation marks
- Made from FDA, EC 1935/2004 & EU 10/2011 conforming polymers
- BSE/TSE Free
- Full Batch Traceability
- Available sterile (SAL 10⁻⁶) and non-sterile



Polypropylene (PP) - Translucent

Part No.	Nominal Volume	Sterile	Diameter	Height	Graduated	Box Quantity
8008P-25	25ml	No	38mm	46mm	Yes	50
8008P-25S	25ml	Yes	38mm	46mm	Yes	50
8008P-50	50ml	No	48mm	54mm	Yes	50
8008P-50S	50ml	Yes	48mm	54mm	Yes	50
8008P-100	100ml	No	57mm	70mm	Yes	50
8008P-100S	100ml	Yes	57mm	70mm	Yes	50
8008P-250	250ml	No	74mm	108mm	Yes	40
8008P-250S	250ml	Yes	74mm	108mm	Yes	40
8008P-2000	2000ml	No	146mm	195mm	Yes	15
8008P-2000S	2000ml	Yes	146mm	195mm	Yes	15



SteriWare® Jugs

Cleanroom manufactured

Volume 500ml to 2000ml

Our range of high quality jugs are designed to be used straight from the bag, no cleaning is required. The specially designed ergonomic handle is rounded to make it comfortable to hold and use.

- Manufactured and packed in a Cleanroom
- Individually Bagged
- Graduation marks (500ml and 1000ml sizes only)
- Made from FDA, EC 1935/2004 & EU 10/2011 conforming polymers
- BSE/TSE Free
- Full Batch Traceability
- Available sterile (SAL 10⁻⁶) and non-sterile



Polypropylene (PP) - Translucent

Part No.	Nominal Volume	Sterile	Diameter	Height	Graduated	Box Quantity
8432P-500	500ml	No	90mm	130mm	Yes	35
8432P-500S	500ml	Yes	90mm	130mm	Yes	35
8432P-1000	1000ml	No	120mm	170mm	Yes	18
8432P-1000S	1000ml	Yes	120mm	170mm	Yes	18



HDPE - Translucent

Part No.	Nominal Volume	Sterile	Diameter	Height	Graduated	Box Quantity
8049H-2000	2000ml	No	129mm	167mm	No	20
8049H-2000S	2000ml	Yes	129mm	167mm	No	16



Disposables

Funnels



- Different designs for liquids and powders
- Manufactured and packed in a Cleanroom
- Individually Bagged
- Made from FDA, EC 1935/2004 & EU 10/2011 conforming HDPE and PP
- BSE/TSE Free
- Full Batch Traceability
- Available sterile (SAL 10⁻⁶) and non-sterile

SteriWare® Liquid Funnel

Narrow spouts for use with liquids and suspensions

HDPE - NATURAL

Part No.	Top Diameter	Spout Diameter	Sterile	Box Quantity
8370H-50	50mm	8mm	No	100
8370H-50S	50mm	8mm	Yes	100
8370H-100	100mm	11mm	No	50
8370H-100S	100mm	11mm	Yes	50
8370H-200	200mm	19mm	No	10
8370H-200S	200mm	19mm	Yes	10
8370H-250	250mm	30mm	No	TBC
8370H-250S	250mm	30mm	Yes	TBC



PP (Polypropylene) - BLUE

Part No.	Top Diameter	Spout Diameter	Sterile	Box Quantity
8370B-100	100mm	11mm	No	50
8370B-100S	100mm	11mm	Yes	50



ULTRA Liquid Funnel

USP Class VI - Double Bagged

- ✓ Made from HDPE, USP Class VI
- ✓ USP Class 661, FDA and EC conforming
- ✓ BSE/TSE free
- ✓ Double Bagged
- ✓ Made and packed in a Cleanroom

Part No.	Top Diameter	Sterile	Box Quantity
9370H-50S	50mm	Yes	40
9370H-100S	100mm	Yes	20



SteriWare® Powder Funnel

Wide mouth funnel - Ideal for Powders and Creams

HDPE - Natural

- Wide spout to aid powder flow

Part No.	Top Diameter	Spout Diameter	Sterile	Box Quantity
8111H-50	50mm	18mm	No	50
8111H-50S	50mm	18mm	Yes	50
8111H-100	100mm	23mm	No	20
8111H-100S	100mm	23mm	Yes	20
8111H-200	200mm	43mm	No	10
8111H-200S	200mm	43mm	Yes	10
8111H-250	250mm	54mm	No	TBC
8111H-250S	250mm	54mm	Yes	TBC



PP (Polypropylene) - Natural

- Wide spout to aid powder flow

Part No.	Top Diameter	Spout Diameter	Sterile	Box Quantity
8111P-350	343mm	52mm	No	8
8111P-350S	343mm	52mm	Yes	8



NOTE: The 343mm size funnels are not made in a Cleanroom. After they have been moulded they are taken into the Cleanroom where they are inspected, air-cleaned and then packed.



Ergonomic Handles on 2 sides
(50mm, 100mm & 250mm sizes)

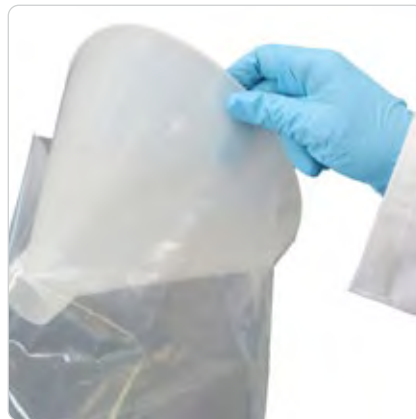

Individually Bagged



Wide Range of Sizes From Stock

Disposables

ULTRA Powder Funnel

USP Class VI - Double Bagged

- ✓ Made from HDPE, USP Class VI
- ✓ USP Class 661, FDA and EC conforming
- ✓ BSE/TSE free
- ✓ Double Bagged
- ✓ Made and packed in a Cleanroom

Part No.	Top Diameter	Sterile	Box Quantity
9111H-200S	200mm	Yes	10

USP Class VI
Double Bagged



SteriWare®
Ultra

Cleaning Validation



SteriWare® Cleaning Coupons

Ensure the effectiveness of cleaning protocols



Cleaning Coupons are used to give a true representation of the effectiveness of cleaning protocols. It is therefore essential that Cleaning Coupons do not introduce errors due to contamination.

SteriWare Cleaning Coupons are manufactured and bagged in a Cleanroom. They are designed to be used straight from the bag.

SteriWare Cleaning Coupons are available in a range of different polymers and in two sizes.

- Manufactured and packed in a Cleanroom
- Individually Bagged
- Available sterile or non-sterile
- Full Batch Traceability



For our complete range of reusable cleaning coupons please see page 172

Part No.	Nominal Dimensions	Material	Sterile	Pack Quantity
8352H-50	50 x 50mm	HDPE	No	50
8352H-50S	50 x 50mm	HDPE	Yes	50
8352H-100	100 x 100mm	HDPE	No	50
8352H-100S	100 x 100mm	HDPE	Yes	50
8352PP-50	50 x 50mm	Polypropylene (PP)	No	50
8352PP-50S	50 x 50mm	Polypropylene (PP)	Yes	50
8352PP-100	100 x 100mm	Polypropylene (PP)	No	50
8352PP-100S	100 x 100mm	Polypropylene (PP)	Yes	50
8352PS-50	50 x 50mm	Polystyrene (PS)	No	50
8352PS-50S	50 x 50mm	Polystyrene (PS)	Yes	50
8352PS-100	100 x 100mm	Polystyrene (PS)	No	50
8352PS-100S	100 x 100mm	Polystyrene (PS)	Yes	50
8352N-50	50 x 50mm	Nylon	No	50
8352N-50S	50 x 50mm	Nylon	Yes	50
8352N-100	100 x 100mm	Nylon	No	50
8352N-100S	100 x 100mm	Nylon	Yes	50
8352PVC-50	50 x 50mm	PVC	No	50
8352PVC-50S	50 x 50mm	PVC	Yes	50
8352PVC-100	100 x 100mm	PVC	No	50
8352PVC-100S	100 x 100mm	PVC	Yes	50

Swabbing Kits

High reach swabbing tools

A reproducible swabbing technique is vital for obtaining meaningful results during Cleaning Validation and environmental swabbing. Our swabbing kits allow the operator to make sure that a consistent area is swabbed.

Swab Holder Kits - include a Universal Swab Holder attached to a telescopic pole

Swab Kit - includes a Swabbing Template attached to a telescopic pole

Swab Kit (3044B)



- Each Swab Kit contains
- 1 x Telescopic Rod 3m
 - 1 x Elbow connector
 - 1 box Swabbing Templates* (50 per box)

* A choice of two template sizes is available. They are also available sterile or non-sterile.

The single use, plastic template will be in contact with the item being swabbed. In order to minimise the risk of sampling error the Swabbing Templates are made and packed within a Cleanroom.

- Made & Packed in a Cleanroom
- Individually Bagged
- Available sterile or non-sterile
- Full Batch Traceability
- 50 templates per box

Swab Holder Kit (3044C)



- Each Swab Holder Kit contains:
- 1 x Telescopic Rod 3m
 - 1 x Elbow connector
 - 1 x Universal Swab Holder (316L ss)

The Universal Swab Holder is designed to work with most makes of stick swabs and cloth swabs. The Swab Holder is made from hygienic 316L stainless steel.

Note: Swabs are not included with the Swab Holder Kit.



Swab Kit 100 (3044B-100)

Swab Holder Kit (3044C-01)



Swabbing Templates can be hand held

Disposables

Swabbing Kits

Part No.	Description
3044B-50	Swab Kit 50 - includes Swabbing Templates 50 x 50mm (50 per box)
3044B-50S	Swab Kit 50S - includes STERILE Swabbing Templates 50 x 50mm (50 per box)
3044B-100	Swab Kit 100 - includes Swabbing Templates 100 x 100mm (50 per box)
3044B-100S	Swab Kit 100S - includes STERILE Swabbing Templates 100 x 100mm (50 per box)
3044C-01	Swab Holder Kit

NOTE: Longer Telescopic Rods are available - ask for details

SPARE SteriWare® Swabbing Templates

Part No.	Nominal Hole Dimensions	Material	Sterile	Box Quantity
8888H-50	50 x 50mm	HDPE	No	50
8888H-50S	50 x 50mm	HDPE	Yes	50
8888H-100	100 x 100mm	HDPE	No	50
8888H-100S	100 x 100mm	HDPE	Yes	50



SteriWare® Mono Slot Sampler

Single Point Sampler - 50ml

Volume 50ml to 100ml

The disposable Mono Slot Sampler is ideal for taking a single sample from free-flowing powders and granules. The sampling slot is positioned near the tip of the sampler.

- Manufactured and packed in a Cleanroom
- Individually Bagged
- Made from FDA, EC 1935/2004 & EU 10/2011 conforming HDPE
- BSE/TSE Free
- Full Batch Traceability
- Available sterile (SAL 10⁻⁶) and non-sterile

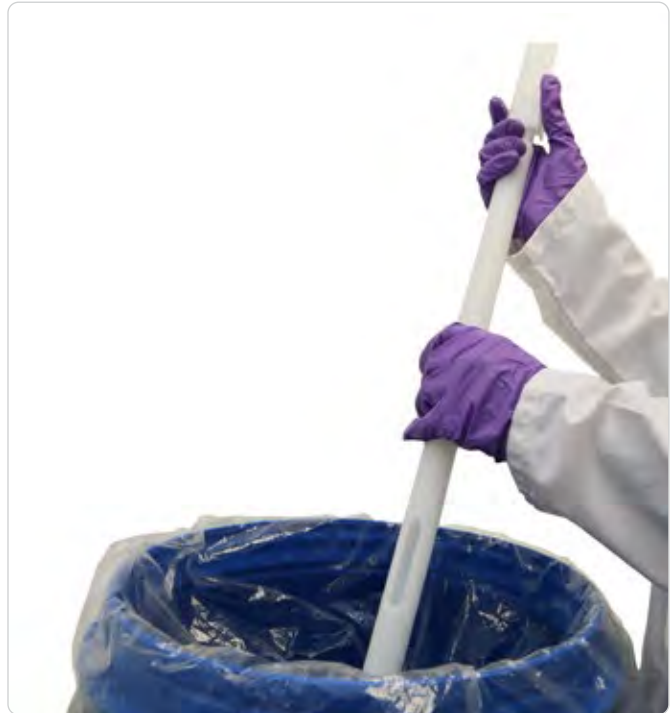

Disposables

Operation

The disposable Mono Slot Sampler is designed for use with free-flowing powders and granules:

1. Push the sampler into the product
2. Rotate handle to open up the slot
3. After leaving the sampler for several seconds to allow powder to enter, rotate handle to close the sampler
4. Remove sampler
5. Slide the inner rod out of the outer tube
6. Deposit the sample into a suitable container

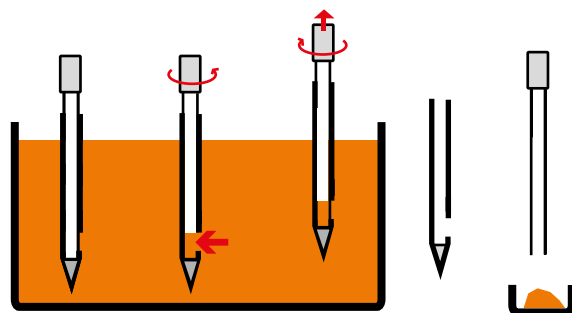

Part No.	Sterile	Overall Length	Nominal Sample Volume	Overall Diameter	Material	Box Quantity
8069H-500	No	620mm	50ml	26mm	HDPE	20
8069H-500S	Yes	620mm	50ml	26mm	HDPE	20
8069H-1000	No	968mm	50ml	26mm	HDPE	20
8069H-1000S	Yes	968mm	50ml	26mm	HDPE	20
8240H-1000	No	987mm	100ml	40mm	HDPE	20
8240H-1000S	Yes	987mm	100ml	40mm	HDPE	20

SteriWare® Slot Sampler

Cross Sectional Multilevel Sampler

Volume 50ml to 500ml

New sizes

The disposable Slot Sampler is ideal for taking a multilevel, cross sectional sample from free-flowing powders and granules.

This sampler is designed to take a single composite sample from the top, middle and bottom of your powder bed.

- Manufactured and packed in a Cleanroom
- Individually Bagged
- Made from FDA, EC 1935/2004 & EU 10/2011 conforming HDPE
- BSE/TSE Free
- Full Batch Traceability
- Available sterile (SAL 10⁻⁶) and non-sterile



SteriWare®



Disposables

Operation

The Disposable Slot Sampler is quick and easy to use:

1. Push the sampler into the product
2. Rotate handle to open up slots
3. After leaving the sampler for several seconds to allow powder to enter, rotate handle to close the sampler.
4. Remove sampler
5. Slide the inner rod out of the outer tube
6. Deposit the sample into a suitable container

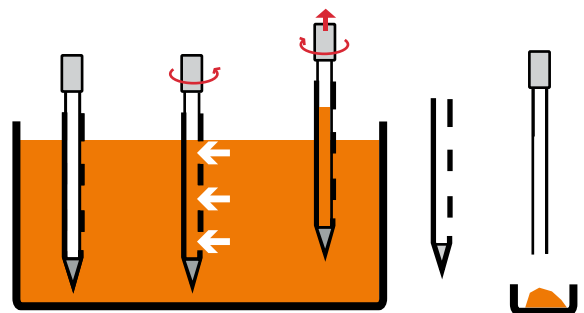

Part No.	Sterile	Overall Length	Nominal Sample volume	Overall Diameter	Material	Box Quantity
8073H-300	No	420mm	50ml	26mm	HDPE	20
8073H-300S	Yes	420mm	50ml	26mm	HDPE	20
8073H-500	No	620mm	100ml	26mm	HDPE	20
8073H-500S	Yes	620mm	100ml	26mm	HDPE	20
8073H-1000	No	968mm	170ml	26mm	HDPE	20
8073H-1000S	Yes	968mm	170ml	26mm	HDPE	20
8073J-1000	No	986mm	500ml	40mm	HDPE	20
8073J-1000S	Yes	986mm	500ml	40mm	HDPE	20

SteriWare® Spatulas



Spatulas are used for taking samples and for dispensing small quantities of powders. We supply spatulas to thousands of laboratories and factories all over the world.

Sampling Systems offers a huge range of spatulas each uniquely designed for a specific use. Variations include:

1. Blade Shape

Spatulas are available with either our traditional 'U' shaped or a 'V' shaped blade.

- The choice is essentially personal preference however:
- V-shaped spatulas tend to have a more pointed tip
 - U-shaped spatulas tend to have larger sample volumes

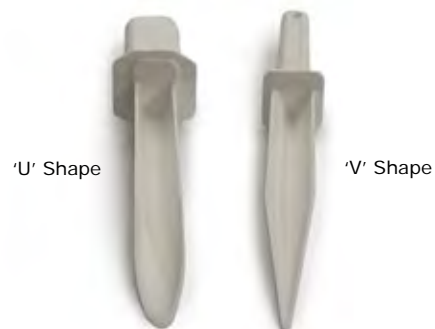

2. Blade Style

Spatulas are available with an 'Open' Tip or a 'Closed' blade. The closed spatulas are shaped like the front of a boat.

- Open Tip - traditional style
- Closed Tip - ideal for use with free-flowing powders as the spatula retains the powder



3. Colour

A contrasting colour makes it easier to see a spatula that has been left in the product.



Disposables

SteriWare® Powder Spatula

Extremely popular OPEN spatula

The SteriWare Powder Spatula is one of our most popular single use sampling tools. Sampling and dispensing small quantities of powders has never been easier thanks to the Powder Spatula.

The Powder Spatula is made from robust, shatter-proof food grade polymers. The handle is designed to be comfortable to use.

They are manufactured and packed in a Cleanroom and can be used straight from the bag. They are all packed in our ultra-strong packaging that is also designed to be easily opened.

- U-shaped Blade
- OPEN style blade
- Manufactured and packed in a Cleanroom
- Individually Bagged
- FDA & EU 10/2011 Conforming Materials
- BSE/TSE Free
- Full Batch Traceability
- Available Sterile (gamma irradiated)
- 5 year shelf life



Polystyrene (PS) - WHITE

Part No.	Sterile	Blade Length	Overall Length	Blade Shape*	Blade Style*	Box Quantity
8095A-150	No	150mm	230mm	U	Open	100
8095A-150S	Yes	150mm	230mm	U	Open	100
8095A-250	No	250mm	330mm	U	Open	100
8095A-250S	Yes	250mm	330mm	U	Open	100

Best Seller



Polystyrene (PS) - RED

Part No.	Sterile	Blade Length	Overall Length	Blade Shape*	Blade Style*	Box Quantity
8095R-150	No	150mm	230mm	U	Open	100
8095R-150S	Yes	150mm	230mm	U	Open	100
8095R-250	No	250mm	330mm	U	Open	100
8095R-250S	Yes	250mm	330mm	U	Open	100



HDPE - Natural

Part No.	Sterile	Blade Length	Overall Length	Blade Shape*	Blade Style*	Box Quantity
8095H-150	No	150mm	230mm	U	Open	100
8095H-150S	Yes	150mm	230mm	U	Open	100



Polypropylene (PP) - BLUE

Part No.	Sterile	Blade Length	Overall Length	Blade Shape*	Blade Style*	Box Quantity
8095B-150	No	150mm	230mm	U	Open	100
8095B-150S	Yes	150mm	230mm	U	Open	100
8095B-250	No	250mm	330mm	U	Open	100
8095B-250S	Yes	250mm	330mm	U	Open	100



* See page 34 for an explanation of the different Blade Shapes and Styles

SteriWare® V-Spatula (OPEN)

V shape powder spatulas with an OPEN blade

These V-Spatulas have the classic OPEN TIP design. They are ideal for dispensing and sampling small quantities.

OPEN V-Spatulas are available in three lengths and two widths to ensure that you always have the perfect spatula for your requirements.

- Ideal for general sampling and dispensing
- Suitable for free-flowing and cohesive powders
- Ergonomic handle
- Free standing design



- V-shaped Blade
- Open Tip
- Manufactured and packed in a Cleanroom
- Individually Bagged
- FDA & EU 10/2011 conforming polystyrene (PS)
- BSE/TSE Free
- Full Batch Traceability
- Available Sterile (SAL 10⁻⁶)
- 5 year shelf life



10mm Wide NARROW Blade - Polystyrene (PS)

Part No.	Blade Length	Overall Length	Sterile	Blade Shape*	Blade Style*	Box Quantity
8440N-100	100mm	198mm	No	V	Open	100
8440N-100S	100mm	198mm	Yes	V	Open	100
8440N-150	150mm	248mm	No	V	Open	100
8440N-150S	150mm	248mm	Yes	V	Open	100
8440N-250	250mm	345mm	No	V	Open	100
8440N-250S	250mm	345mm	Yes	V	Open	100



20mm Wide STANDARD Blade - Polystyrene (PS)

Part No.	Blade Length	Overall Length	Sterile	Blade Shape*	Blade Style*	Box Quantity
8440A-100	100mm	198mm	No	V	Open	100
8440A-100S	100mm	198mm	Yes	V	Open	100
8440A-150	150mm	248mm	No	V	Open	100
8440A-150S	150mm	248mm	Yes	V	Open	100
8440A-250	250mm	345mm	No	V	Open	100
8440A-250S	250mm	345mm	Yes	V	Open	100



* See page 34 for an explanation of the different Blade Shapes and Styles

SteriWare® V-Spatula (CLOSED)

Closed Tip

Volume 1.4ml to 25ml

This type of V-Spatula has a special CLOSED TIP which is designed to retain powder. The Closed Spatulas are free standing which means that they are perfect for weighing small quantities of powders and granules.

- Ideal for sampling a fixed volume and general dispensing
- Suitable for free-flowing and cohesive powders
- Ergonomic handle
- Free standing design



- V-shaped Blade
- Closed Tip
- Manufactured and packed in a Cleanroom
- Individually Bagged
- FDA & EU 10/2011 conforming polystyrene
- BSE/TSE Free
- Full Batch Traceability
- Available Sterile (SAL 10⁻⁶)
- 5 year shelf life



Disposables

10mm Wide NARROW Blade - Polystyrene (PS)

Part No.	Blade Length	Overall Length	Nominal Volume	Sterile	Blade Shape*	Blade Style*	Box Quantity
8115N-100	100mm	198mm	1.4ml	No	V	Closed	100
8115N-100S	100mm	198mm	1.4ml	Yes	V	Closed	100
8115N-150	150mm	248mm	2.3ml	No	V	Closed	100
8115N-150S	150mm	248mm	2.3ml	Yes	V	Closed	100
8115N-250	250mm	348mm	4ml	No	V	Closed	100
8115N-250S	250mm	348mm	4ml	Yes	V	Closed	100



20mm Wide STANDARD Blade - Polystyrene (PS)

Part No.	Blade Length	Overall Length	Nominal Volume	Sterile	Blade Shape*	Blade Style*	Box Quantity
8115A-100	100mm	198mm	7ml	No	V	Closed	100
8115A-100S	100mm	198mm	7ml	Yes	V	Closed	100
8115A-150	150mm	248mm	11ml	No	V	Closed	100
8115A-150S	150mm	248mm	11ml	Yes	V	Closed	100
8115A-250	250mm	348mm	25ml	No	V	Closed	100
8115A-250S	250mm	348mm	25ml	Yes	V	Closed	100



* See page 34 for an explanation of the different Blade Shapes and Styles

SteriWare® PowderSafe

Spatula with a click-on Container

The PowderSafe comprises of our best selling Powder Spatula complete with a click-on container. The see-through container slips over the blade of the spatula and is securely locked into place.

At the laboratory the cover can be easily removed.

- Manufactured and packed in a Cleanroom
- Individually Bagged
- Made from FDA, EC 1935/2004 & EU 10/2011 conforming Materials
- BSE/TSE Free
- Full Batch Traceability
- Available sterile (SAL 10⁻⁶) and non-sterile

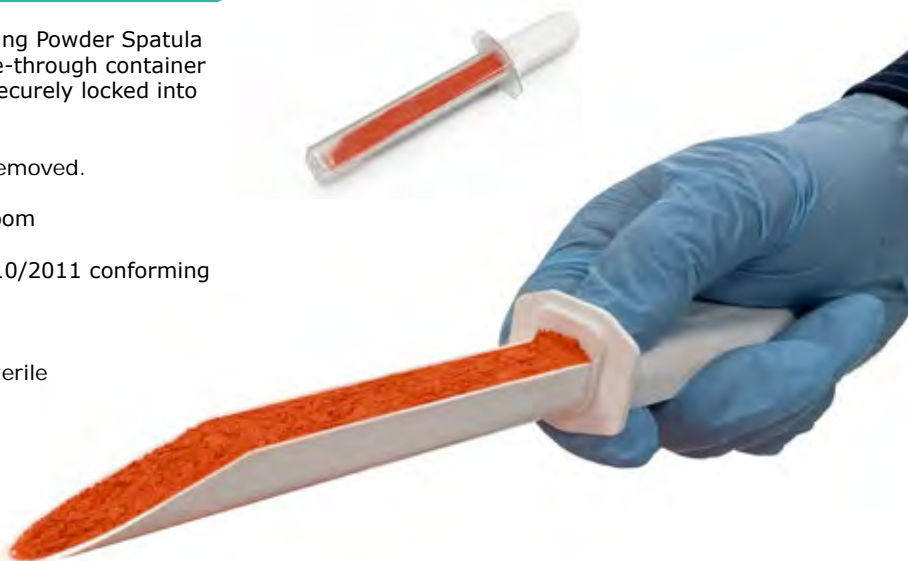

Polystyrene (PS)

Part No.	Blade Length	Overall length	Sterile	Box Quantity
8097A-150	150mm	230mm	No	100
8097A-150S	150mm	230mm	Yes	100



Disposables

SteriWare®



Try before you buy

Give us a call for a free sample

SteriWare® Powder Thief

Best Selling Powder Sampler

Volume 0.5ml to 20ml

New sizes



The disposable PowderThief is designed for taking a single sample from a known location within the container. These samplers are available in three lengths and seven sample volumes.

The SteriWare PowderThief is suitable for use with free-flowing powders and granules.

- Manufactured and packed in a Cleanroom
- Individually Bagged
- Made from FDA, EC 1935/2004 & EU 10/2011 conforming HDPE
- BSE/TSE Free
- Full Batch Traceability
- Available sterile (SAL 10⁻⁶) and non-sterile

Operation

1. Insert the sampler into the product. Ensure that the tip is inside the sampler body
2. At the required depth pull up the body to expose the tip. The sample will fall in around the tip
3. Push down body of the sampler to trap the sample
4. Withdraw sampler
5. Pull up body to empty sample

HDPE - Natural

Part No.	Sterile	Nominal Tip Size	Nominal Length	Overall Diameter	Box Quantity
8060H-500.5	No	0.5ml	511mm	21mm	20
8060H-500.5S	Yes	0.5ml	511mm	21mm	20
8060H-501	No	1ml	511mm	21mm	20
8060H-501S	Yes	1ml	511mm	21mm	20
8060H-502S	Yes	2ml	511mm	21mm	20
8060H-503S	Yes	3ml	511mm	21mm	20
8060H-505	No	5ml	511mm	21mm	20
8060H-505S	Yes	5ml	511mm	21mm	20
8060H-510	No	10ml	511mm	21mm	20
8060H-510S	Yes	10ml	511mm	21mm	20
8060H-520	No	20ml	511mm	21mm	20
8060H-520S	Yes	20ml	511mm	21mm	20
8060H-1000.5S	Yes	0.5ml	987mm	21mm	20
8060H-1001	No	1ml	987mm	21mm	20
8060H-1001S	Yes	1ml	987mm	21mm	20
8060H-1002S	Yes	2ml	987mm	21mm	20
8060H-1003S	Yes	3ml	987mm	21mm	20
8060H-1005	No	5ml	987mm	21mm	20
8060H-1005S	Yes	5ml	987mm	21mm	20
8060H-1010	No	10ml	987mm	21mm	20
8060H-1010S	Yes	10ml	987mm	21mm	20
8060H-1020	No	20ml	987mm	21mm	20
8060H-1020S	Yes	20ml	987mm	21mm	20
8060H-1520	No	20ml	1500mm	21mm	20
8060H-1520S	Yes	20ml	1500mm	21mm	20

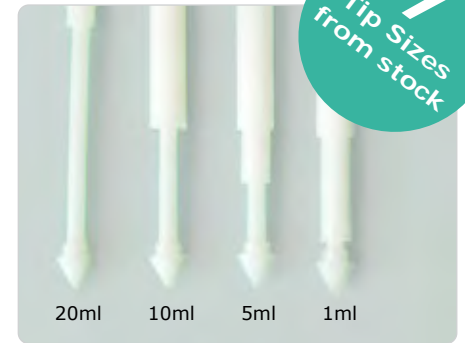
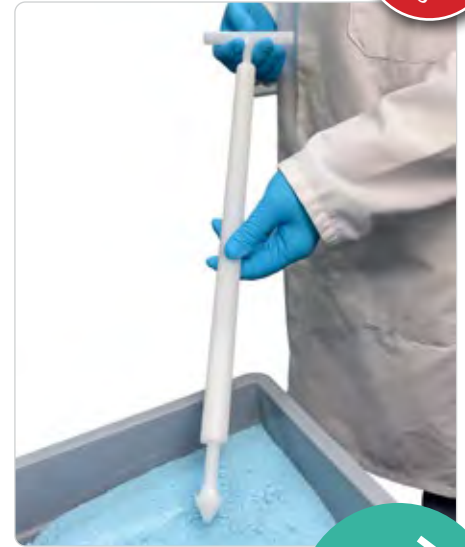

7 Tip Sizes from stock

Available tip sizes: 0.5ml, 1ml, 2ml, 3ml, 5ml, 10ml and 20ml



Disposables

SteriWare® Powder Probe

Cross Sectional Sampler for Free-Flowing Powders

Volume 125ml to 200ml

The disposable Powder Probe is ideal for taking a cross-sectional sample through a bulk powder. It is similar to the Powder Lance (page 41) but has an additional tip on the end. The tip stops the powder flowing out.

- Manufactured and packed in a Cleanroom
- Individually Bagged
- Made from FDA, EC 1935/2004 & EU 10/2011 conforming HDPE
- BSE/TSE Free
- Full Batch Traceability
- Available sterile (SAL 10⁻⁶) and non-sterile

Operation

The disposable Powder Probe is quick and easy to use:

1. Push the disposable Powder Probe into the product, rotate the sampler and then withdraw
2. Deposit the sample into a suitable container
3. Place the used sampler into its plastic bag



HDPE - Natural

Part No.	Sterile	Blade Length	Overall Length	Nominal Sample Volume	Box Quantity
8064H-500	No	497mm	615mm	125ml	20
8064H-500S	Yes	497mm	615mm	125ml	20
8064H-1000	No	845mm	945mm	200ml	20
8064H-1000S	Yes	845mm	945mm	200ml	20



Can't find what you need?

Call Us for free advice.

We also make specials on request

SteriWare® Powder Lance

Cross Sectional Sampler for Cohesive Powders

Volume 75ml to 200ml

The open blade of the disposable Powder Lance makes it ideal for taking a cross sectional sample through a sticky, cohesive powder.

- Manufactured and packed in a Cleanroom
- Individually Bagged
- Made from FDA, EC 1935/2004 & EU 10/2011 conforming HDPE
- BSE/TSE Free
- Full Batch Traceability
- Available sterile (SAL 10⁻⁶) and non-sterile



Disposables



Operation

The disposable Powder Lance is quick and easy to use:

1. Push the disposable Powder Lance into the product, rotate the sampler and then withdraw
2. Deposit the sample into a suitable container
3. Place the used sampler into its plastic bag

HDPE - Natural

Part No.	Sterile	Blade Length	Overall Length	Nominal Sample Volume	Box Quantity
8063H-300	No	300mm	401mm	75ml	20
8063H-300S	Yes	300mm	401mm	75ml	20
8063H-500	No	500mm	601mm	125ml	20
8063H-500S	Yes	500mm	601mm	125ml	20
8063H-1000	No	851mm	953mm	200ml	20
8063H-1000S	Yes	851mm	953mm	200ml	20



Disposable Sack Sampler

Take a sample through the side of a Sack

The disposable Sack Sampler is a hygienic, single use device that has been specially designed to take samples of free-flowing powders and granules through the side of a sack.

- Individually Bagged
- Made from FDA, EC 1935/2004 & EU 10/2011 Conforming Materials
- BSE/TSE Free
- Full Batch Traceability
- Available sterile (SAL 10⁻⁶) and non-sterile

Operation:

1. Insert the sampler through a sampling hole in the side of the sack.
2. Angle sampler downwards to allow the product to flow into the sample collecting bag
3. Seal hole with an Ultra Adhesive label (see page 181)



HDPE - Natural

Part No.	Length	Diameter	Sterile	Box Quantity
8085A-100	400mm	25mm	No	100
8085A-100S	400mm	25mm	Yes	100
8080A-450	Sample Collecting Bag 450ml - for hygienic use - sterile			Quantity: 1000 bags
8080A-900	Sample Collecting Bag 900ml - for hygienic use - sterile			Quantity: 1000 bags



SteriWare®

Download Certificates

Batch specific Certificates of Conformity and Certificates of Irradiation* are available for download from:

www.sampling.com/certs

Simply enter your batch number into the search box and download your certificates in PDF format. You will find your batch number printed on the box label and on every bag.

**Certificates of Irradiation are not available for products that are sold as "non-sterile"*

SteriWare® Sack and Bag Sampler

Perfect for taking samples from sacks and bags

The SteriWare Sack and Bag Sampler is perfect for taking samples from sacks and bags. This sampler is ideal for fast quality checks through the sides of the sacks. The SteriWare Sack Sampler is available in two diameters. The narrow sack sampler (25mm) is ideal for free-flowing powders and for small products like pepper corns and small grains whereas the large diameter sampler (45mm) is more suited to sampling nuts and beans.

The SteriWare Sack Sampler has an ergonomic handle and specially designed blade.

During sampling the operator needs to hold a bag or bottle over the rear end of the sampler to catch the powder or granules as they slide through the sampler.

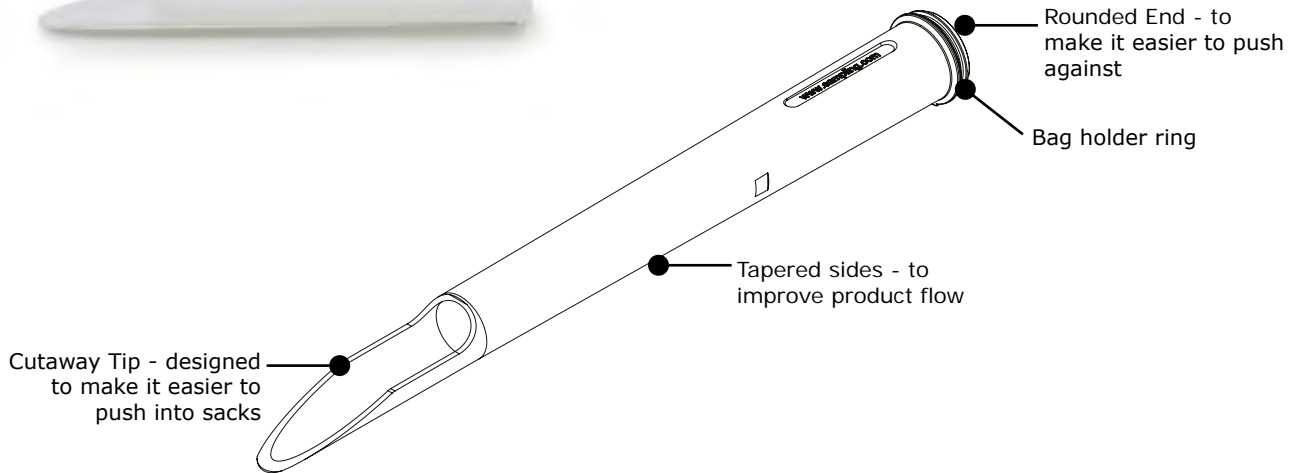

Operation:

1. Insert the sampler through a sampling hole in the side of the sack.
2. Angle sampler downwards to allow the product to flow into the sample collecting bag
3. Seal hole with an Ultra Adhesive label (see pages 180 to 186)

HDPE - Natural

Part No.	Sterile	Length	Diameter	Box Quantity
8688H-330	No	325mm	33mm	100
8688H-330S	Yes	325mm	33mm	100
8688J-330	No	325mm	45mm	100
8688J-330S	Yes	325mm	45mm	100



Disposables

Use Ultra Adhesive Labels to seal the sacks after sampling.

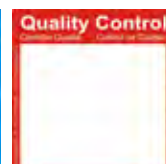
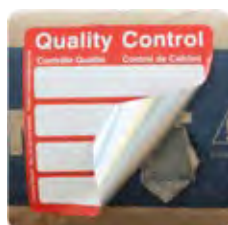

See the full range of labels on pages 180 to 186

SteriWare® LiquiDip Duo

The Self Closing Liquid Sampler

Volume 80ml to 225ml

The LiquiDip Duo sampler from Sampling Systems is ideal for taking cross sectional or point samples of liquids. The sampler has a special valve at each end of the sampler. The valve automatically closes when it is pushed against the bottom of the container.

The LiquiDip Duo is ideal for sampling low viscosity liquids.

- Individually bagged
- Made from FDA, EC 1935/2004 & EU 10/2011 conforming materials
- Manufactured and packed in a Cleanroom
- Available from stock for fast delivery worldwide
- 100% HDPE (no seal required)
- Available sterile (SAL 10⁻⁶) and non-sterile

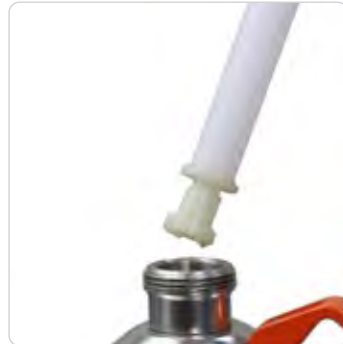

The LiquiDip Duo is a versatile sampler for taking both cross sectional samples and point samples.

Point Sampling -

1. Close the top valve.
2. Push sampler into the liquid to the point required.
3. Open top valve and let liquid flow in.
4. Close top valve and remove sampler

Cross Sectional Sampling -

1. Ensure the top and bottom valves are open
2. Push sampler into the container until it reaches the bottom.
3. Push sampler against the container base to close both valves.
4. Close top valve with hand to ensure liquid is trapped inside

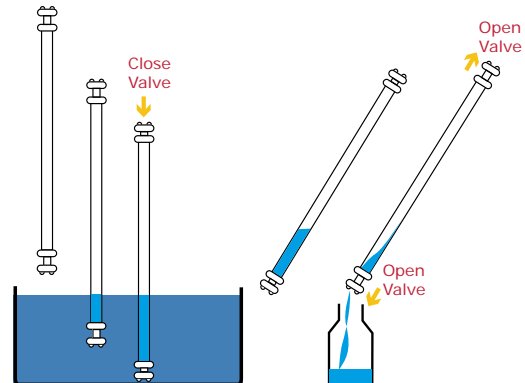
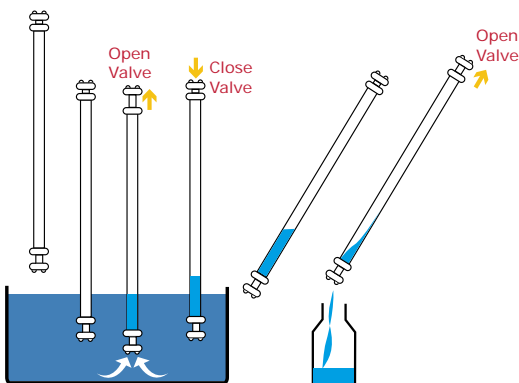

HDPE - Natural

Part No.	Nominal Capacity	Sterile	Length	Box Quantity
8921H-450	80ml	No	456mm	20
8921H-450S	80ml	Yes	456mm	20
8921H-1100	225ml	No	1125mm	20
8921H-1100S	225ml	Yes	1125mm	20



SteriWare® LiquiThief

Liquid Sampling Without Costly Cleaning

Volume 100ml to 300ml

Sampling Systems revolutionised liquid sampling with the introduction of the LiquiThief. This sampler is ideal for use with low viscosity liquids (e.g. water).

- Assembled & Packed in a Cleanroom
- Individually Bagged
- Made from FDA, EC 1935/2004 & EU 10/2011 conforming materials
- BSE/TSE Free
- Full Batch Traceability
- Available sterile (SAL 10⁻⁶) and non-sterile



Operation:

1. Insert the sampler into the product
2. At the required depth pull up the handle. The sample will be drawn into the sampler
3. Withdraw sampler. Push down handle to expel the sample

Note: The further the handle is pulled the greater the sample volume

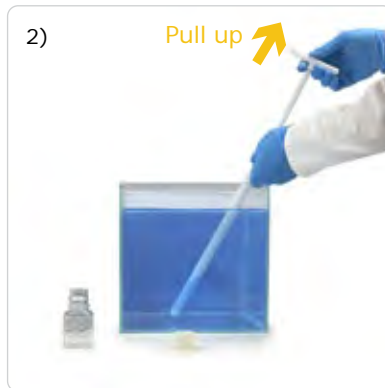

Disposables

HDPE - Natural

Part No.	Nominal Length	Sterile	Max Sample Volume	Diameter of Hole in Tip	Outer Tube Diameter	Box Quantity
8050H-500	500mm	No	100ml	1.5mm	21mm	20
8050H-500S	500mm	Yes	100ml	1.5mm	21mm	20
8050H-1000	1000mm	No	190ml	1.5mm	21mm	20
8050H-1000S	1000mm	Yes	190ml	1.5mm	21mm	20
8050H-1500	1500mm	No	300ml	1.5mm	21mm	20
8050H-1500S	1500mm	Yes	300ml	1.5mm	21mm	20



Polypropylene (PP) - Natural

Part No.	Nominal Length	Sterile	Max Sample Volume	Diameter of Hole in Tip	Outer Tube Diameter	Box Quantity
8050P-500	500mm	No	100ml	1.5mm	21mm	20
8050P-1000	1000mm	No	190ml	1.5mm	21mm	20



SteriWare® Thumb Tube

Low Cost Disposable Liquid Samplers

Volume 60ml

Thumb Tube Pipettes are a very quick and easy way of obtaining a liquid sample from a low/medium viscosity liquid.

- Individually Bagged
- Made from FDA, EC 1935/2004 & EU 10/2011 conforming materials
- BSE/TSE Free
- Manufactured and packed in a Cleanroom
- Available sterile (SAL 10⁻⁶) and non-sterile

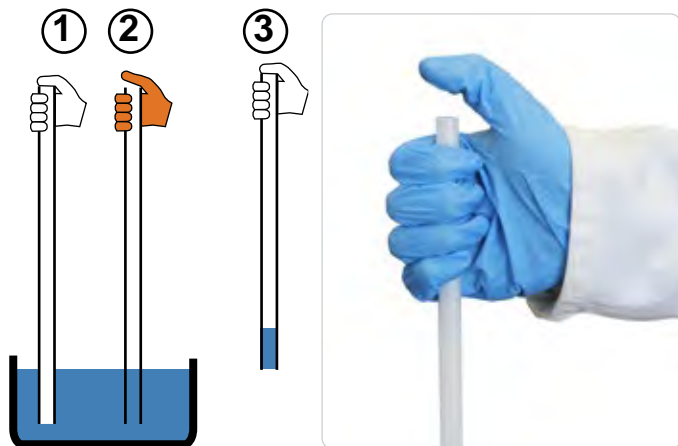

Operation

1. Press thumb onto tube until you are at the sampling depth
2. Raise thumb until levels equalise
3. Cover the end of the tube to seal in the sample



HDPE - Natural

Part No.	Overall Length	Overall Diameter	Internal Diameter	Sterile	Max Sample Volume	Box Quantity
5055A-50	1000mm	12mm	9mm	No	60ml	50
5055A-50S	1000mm	12mm	9mm	Yes	60ml	50



Sample It Label It

See pages 180-186 for our full range of labels

SteriWare® Ladle

Efficient surface sampling of liquids

Volume 50ml to 100ml

The SteriWare Ladle is designed to quickly and efficiently take surface samples from liquids. They are moulded and packed in a Cleanroom and can be used straight from the bag.

The one piece moulded design has been specially made to fit through a standard 2" lid bung. 2" bungs are standard features on many barrels and kegs.

The SteriWare Ladle is ideal for use in production and laboratories. SteriWare Ladles are available in both natural HDPE or blue polypropylene (PP).

- Manufactured and packed in a Cleanroom
- Individually Bagged
- Made from FDA, EC 1935/2004 & EU 10/2011 conforming materials
- BSE/TSE Free
- Full Batch Traceability
- Available sterile (SAL 10⁻⁶) and non-sterile
- Available from stock

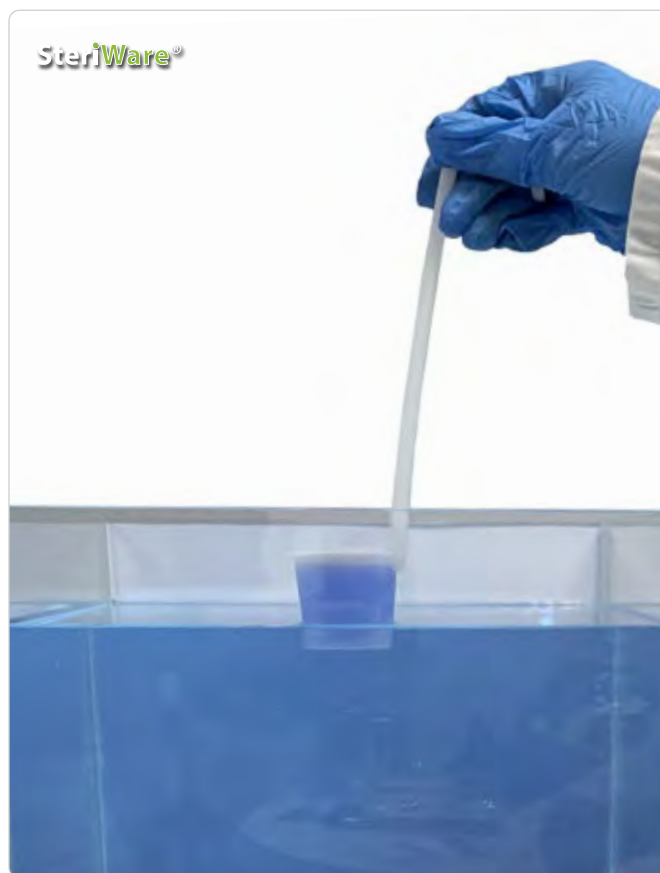

Disposables

HDPE - Natural

Part No.	Nominal Volume	Cup Diameter	Length	Sterile	Box Quantity
8053H-50	50ml	48mm	260mm	No	40
8053H-50S	50ml	48mm	260mm	Yes	40

PP (Polypropylene) - Natural

Part No.	Nominal Volume	Cup Diameter	Length	Sterile	Box Quantity
8053P-100	100ml	43mm	453mm	No	40
8053P-100S	100ml	43mm	453mm	Yes	40

PP (Polypropylene) - BLUE

Part No.	Nominal Volume	Cup Diameter	Length	Sterile	Box Quantity
8053B-50	50ml	48mm	260mm	No	40
8053B-50S	50ml	48mm	260mm	Yes	40



New

New

ULTRA Ladle - HDPE

Double Bagged for Demanding Applications

- ✓ Made from HDPE
- ✓ USP Class 661.1, FDA and EC conforming
- ✓ BSE/TSE free
- ✓ Double Bagged
- ✓ Made and packed in a Cleanroom

Part No.	Nominal Volume	Diameter	Sterile	Box Quantity
9053H-50S	50ml	48mm	Yes	25



SteriWare®
Ultra

SteriWare® Jumbo Pipettes

Low Cost Disposable Liquid Samplers

Volume 80ml to 225ml

SteriWare Jumbo Pipettes are suitable for taking samples from low viscosity liquids (e.g. water).

The 1100mm length sampler is ideal for sampling 200L (55 gallon) drums. It means you can reach the bottom of the container but your hand remains clear of the top.

- Manufactured and packed in a Cleanroom
- Individually Bagged
- Made from FDA, EC 1935/2004 & EU 10/2011 conforming HDPE
- BSE/TSE Free
- Full Batch Traceability
- Highly visible colour coded handle
- Available sterile (SAL 10⁻⁶) and non-sterile



Operation

1. Press thumb onto tube until you are at the correct sampling depth
2. Raise thumb until levels equalize
3. Press thumb onto tube to seal in the sample

The deeper the sampler is pushed into the liquid the larger the sample volume

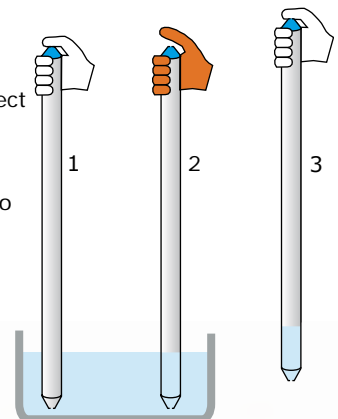

8051H-1100



8051H-900



8051H-450



A unique feature of the Jumbo Pipette

To avoid handling errors one end of the Jumbo Pipette is colour coded blue.

HDPE - Natural & Blue Tip

Part No.	Overall Length	Sterile	Max. Sample Volume	Overall Diameter	Box Quantity
8051H-450	420mm	No	80ml	21mm	50
8051H-450S	420mm	Yes	80ml	21mm	50
8051H-900	892mm	No	180ml	21mm	50
8051H-900S	892mm	Yes	180ml	21mm	50
8051H-1100	1090mm	No	225ml	21mm	37
8051H-1100S	1090mm	Yes	225ml	21mm	37



SteriWare® ViscoThief

Single Use Sampler for High Viscosity Liquids

Volume 100ml to 300ml

The Disposable ViscoThief is ideal for sampling viscous materials such as oils, creams, shampoo and honey.

Quick and easy to use.

- Assembled & Packed in a Cleanroom
- Individually Bagged
- Made from FDA, EC 1935/2004 & EU 10/2011 conforming materials
- BSE/TSE Free
- Full Batch Traceability
- Ergonomic handle
- Available sterile (SAL 10⁻⁶) and non-sterile

Operation:

1. Insert the sampler into the product
2. At the required depth, pull up the handle. The sample will be drawn into the sampler
3. Withdraw sampler
4. Push down handle to expel the sample

Note: The further the handle is pulled the greater the sample volume

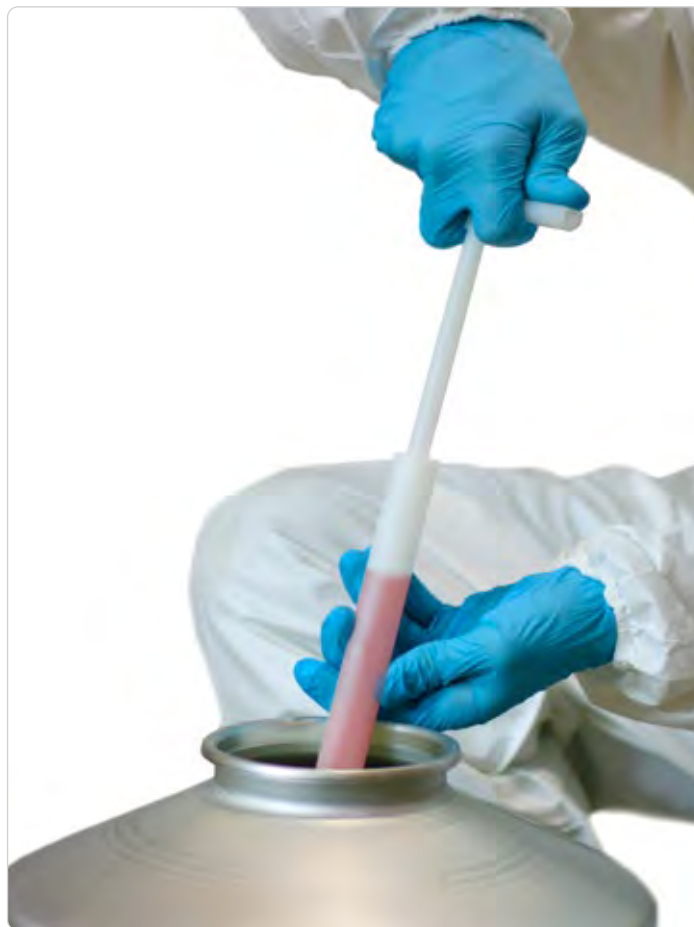
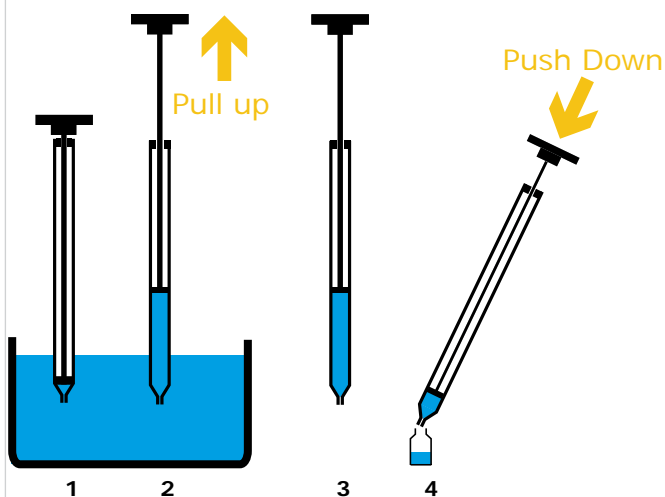

Disposables

HDPE - Natural

Part No.	Nominal Length	Sterile	Max Sample Volume	Diameter of Hole in Tip	Outer Tube Diameter	Box Quantity
8055H-500	500mm	No	100ml	10mm	21mm	20
8055H-500S	500mm	Yes	100ml	10mm	21mm	20
8055H-1000	1000mm	No	190ml	10mm	21mm	20
8055H-1000S	1000mm	Yes	190ml	10mm	21mm	20
8055H-1500	1500mm	No	300ml	10mm	21mm	20
8055H-1500S	1500mm	Yes	300ml	10mm	21mm	20



Polypropylene (PP) - Natural

Part No.	Nominal Length	Sterile	Max Sample Volume	Diameter of Hole in Tip	Outer Tube Diameter	Box Quantity
8055P-500	500mm	No	100ml	10mm	21mm	20
8055P-1000	1000mm	No	190ml	10mm	21mm	20



For low viscosity liquids such as water use the LiquiThief (see page 45)

SteriWare® Cake Sampler

Tool for sampling powder cakes

Cake Samplers are designed to take samples from compacted powder cakes. Each Cake Sampler is individually bagged and can be used straight from the bag. They are made from FDA and EC compliant HDPE.

They are 50mm high with 40mm diameter. They are 100% cleanroom manufactured and packed.

- Manufactured and packed in a Cleanroom
- Individually Bagged
- Made from FDA, EC 1935/2004 & EU 10/2011 conforming materials
- BSE/TSE Free
- Full Batch Traceability
- Available sterile (SAL 10⁻⁶) and non-sterile



New

Part No.	Overall Length	Overall Diameter	Sterile	Material	Box Quantity
8765H-4050	50mm	40mm	No	HDPE	50
8765H-4050S	50mm	40mm	Yes	HDPE	50



Disposables

In House Design

Our design team has worked tirelessly to create unique and innovative designs that are now used by customers all over the world. We take pride in our ability to blend pioneering designs, practical implications and costs to come up with class leading products.

From concept to creation, our team works collaboratively to ensure that each design is a true reflection of our commitment to excellence.

We use the latest CAD software with 3D printers so we can frequently print samples or prototypes before making the final product.

Whether you're looking for a simple alteration or a brand new product please contact us.



Powder Sampling



PowderThief

Best Selling Powder Thief

Volume 0.25ml to 100ml

New
sizes

The PowderThief was originally developed by Sampling Systems over 30 years ago and is now a world leader in powder sampling. It is extensively used throughout the pharmaceutical, chemical and food industries around the world.

The PowderThief is suitable for sampling free-flowing powders and granules. A range of tips is available so that a single sampler body can be used to accurately sample a range of different volumes.

- Ideal for sampling free-flowing powders
- Made from high quality 316L stainless steel
- Wide range of sizes



Tips - various sizes can be attached to the same body to allow different volumes to be sampled

Operation

1. Insert the sampler into the product, ensure that the tip is inside the outer tube.
2. At the required depth pull up the outer tube to expose the tip. Powder will flow in around the tip.
3. Push down the outer tube to trap the sample.
4. Withdraw sampler.
5. Pull up the outer tube to release the sample.

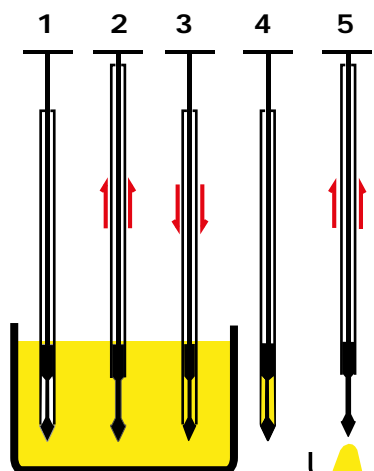

PowderThief samplers are available in a range of different sizes

Sampler Bodies

Part No.	Nominal Sampler Length	Body Diameter
1030A-300	300mm	12.5mm
1030A-600	600mm	12.5mm
1030A-1000	1000mm	12.5mm
1030A-1500	1500mm	12.5mm
1030A-2000	2000mm	12.5mm

1030B-600	600mm	19mm
1030B-1000	1000mm	19mm
1030B-1500	1500mm	19mm
1030B-2000	2000mm	19mm

1030C-600	600mm	25mm
1030C-1000	1000mm	25mm
1030C-1500	1500mm	25mm

1030D-600	600mm	32mm
1030D-1000	1000mm	32mm
1030D-1500	1500mm	32mm
1030D-2000	2000mm	32mm

Options Cleaning Brushes See page 177
 Storage cases See page 176
 XRF Certification See page 118

Sampling Tips

A range of standard tip sizes is available for each body diameter. Special sizes available on request.

Part No.	Tip Sizes	Tip to suit Body Diameter
1030AT-025	0.25ml	12.5mm
1030AT-050	0.50ml	12.5mm
1030AT-075	0.75ml	12.5mm
1030AT-100	1.00ml	12.5mm
1030AT-150	1.50ml	12.5mm
1030AT-200	2.00ml	12.5mm

1030BT-2	2ml	19mm
1030BT-3	3ml	19mm
1030BT-5	5ml	19mm
1030BT-8	8ml	19mm
1030BT-10	10ml	19mm

1030CT-10	10ml	25mm
1030CT-20	20ml	25mm
1030CT-25	25ml	25mm

1030DT-20	20ml	32mm
1030DT-25	25ml	32mm
1030DT-50	50ml	32mm
1030DT-100	100ml	32mm



SteriWare®

Related Product single use, disposable PowderThief

The disposable PowderThief works in the same way as the stainless steel Powder Thief (above). Disposable samplers have the advantage that they can be used straight from the bag and never need to be cleaned, thereby saving you time and money as well as eliminating the risk of cross contamination.

- No risk of cross contamination
- No cleaning required
- No Cleaning Validation
- Save time & money

See page 39 for more information

Slot Sampler (316L ss)

Multilevel Sampler gives a Single Composite Sample

Volume 45ml to 1300ml



The Slot Sampler is ideal for taking a large volume, cross sectional sample from a container. The sampler has a robust all stainless steel construction and is suitable for sampling free-flowing powders and granules.

- Cross section, composite sample
- Suitable for taking large volume samples



Slot Samplers are supplied with pointed tips. Rounded Tips are available as an option.



Operation:

1. Insert the sampler into the product
2. Turn the handle to open the slot - the product flows into the central tube
3. Turn the handle to close the slot
4. Remove the sampler
5. Invert the sampler to discharge the sample

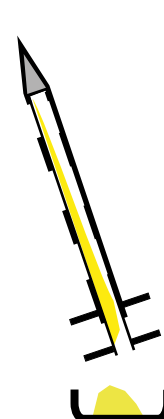
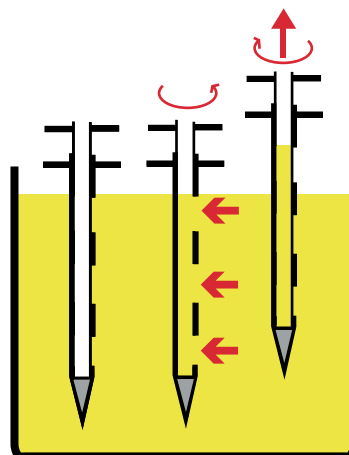

Emptying from standard Sampler

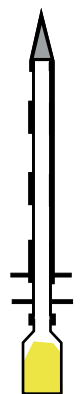

Emptying from sampler with a bottle adapter



The Slot Sampler is available with a bottle holder. This enables the sample to be emptied directly into a bottle.



Sample being discharged from a Standard Slot Sampler without a Bottle Holder

- Improved Containment
- Save time
- Can be used with either a 250ml or 500ml bottle

Part No.	Bottle Holder	Nominal Length	Outer Diameter	Material	Maximum Sample Volume	No of Slots
1210A-300	No	300mm	25mm	316L stainless steel	45ml	3
1210A-600	No	600mm	25mm	316L stainless steel	110ml	3
1210A-1000	No	1000mm	25mm	316L stainless steel	190ml	4
1210A-1500	No	1500mm	25mm	316L stainless steel	300ml	5
1210A-2000	No	2000mm	25mm	316L stainless steel	370ml	5
1210B-600	Yes*	600mm	25mm	316L stainless steel	110ml	3
1210B-1000	Yes*	1000mm	25mm	316L stainless steel	190ml	4
1210B-1500	Yes*	1500mm	25mm	316L stainless steel	300ml	5
1210K-1000	No	1000mm	40mm	316L stainless steel	750ml	3
1210K-1500	No	1500mm	40mm	316L stainless steel	1000ml	4
1210K-2000	No	2000mm	40mm	316L stainless steel	1300ml	4
8165A-250	Sample collecting bottle - 250ml. HDPE					
8165A-500	Sample collecting bottle - 500ml. HDPE					
Additional Tips	See page 60 (for rounded or very pointed tips)					
Cleaning Brushes	See page 177					
Storage Cases	See page 176					
XRF	Material certification verified by XRF (See page 118)					
* Do not forget to order a sample collecting bottle (see above: 8165A-250 & 8165A-500)						

SteriWare®

See page 33 for **Disposable Slot Samplers**



Aluminium Slot Sampler

Designed for taking multilevel, zone samples

Volume 80ml to 2370ml

The Aluminium Slot Sampler is designed for taking multilevel, zone samples from powders and granules. The sampler is made from anodised aluminium and this makes it very lightweight and easy to use.

The Aluminium Slot Sampler has a number of sampling windows which help to ensure it gives a representative, all layer sample. This sampler is suitable for sampling free-flowing powders and granules.

EASY TO USE

The Aluminium Slot Sampler is easy to use. It consists of an inner and outer aluminium tube. Push into the powder in the closed position. When inserted turn the handle to open the sampler - this allows the powder to enter the sampler. Close and remove sampler. Invert the sampler to empty the sample through the handle.



Part No.	Nominal Length	Diameter	Max. Sample Volume	No. of Sampling Points	Material
1610A-600	600mm	25mm	80ml	3	Aluminium
1610A-1000	1000mm	25mm	135ml	5	Aluminium
1610A-1500	1500mm	25mm	190ml	7	Aluminium
1610A-2000	2000mm	25mm	245ml	7	Aluminium
1610A-2500	2500mm	25mm	350ml	10	Aluminium
1210J-900	935mm	50mm	890ml	3	Aluminium
1210J-1500	1570mm	50mm	1630ml	5	Aluminium
1210J-2500	2570mm	50mm	2370ml	7	Aluminium

Spiral Slot Sampler

Designed for taking multilevel, zone samples

Volume 340ml to 860ml

Highly representative sampling is fast and easy with the aluminium Spiral Slot Sampler.

The spiral position of the pockets give superior sampling results. This means the bottom pocket opens and fills first giving a more representative sample.

The sampler is suited for sampling free-flowing powders, granules and grains. This can be from IBC, kegs, silos, railway trucks, ships and almost all applications

The lightweight aluminium construction means even the long samplers are easy to operate and handle. The tip is fixed permanently so it can not become loose and get lost.



Part No.	Nominal Length	Diameter	No. of Sampling Slots	Max. Sample Volume	Material
1942A-1000	1000mm	35mm	4	340ml	Aluminium
1942A-1500	1500mm	35mm	6	525ml	Aluminium
1942A-2000	2000mm	35mm	8	700ml	Aluminium
1942A-2500	2500mm	35mm	10	860ml	Aluminium
1942H-35	Heavy Duty Handle for 35mm diameter samplers (gives extra leverage during use)				

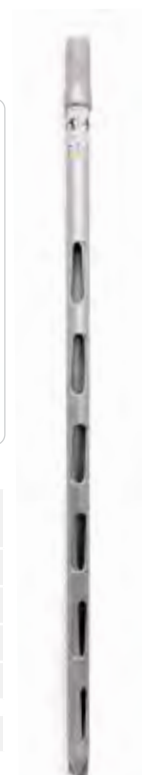

Powder Trier

Ideal for use with compacted powders

Volume 110ml to 300ml

The Sampling Systems Powder Trier is ideal for taking a large volume, cross sectional sample from a container. The sampler has a robust all stainless steel construction and is suitable for sampling cereals, grains, free-flowing powders, granules and even slightly cohesive powders

- Cross section (composite sample)
- 316L stainless steel, bright finish
- Suitable for taking a large volume sample from compacted powders, grains etc.

Operation

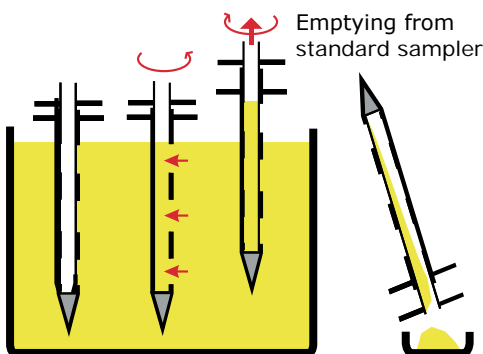

1. Insert the sampler into the product
2. Turn the handle to open the slot - the product can now be collected in the central tube
3. Turn the handle to close the slot
4. Remove the sampler
5. Invert the sampler to discharge the sample

After use the Tip can be unscrewed for easy cleaning

Note: The cutting scroll is not shown in the sketches



Powders Multi Level Sampling



Part No.	Nominal Length	Number of Slots	Sampler Diameter	Maximum Sample volume	Material
1216A-600	600mm	3	25mm (excluding scroll)	110ml	316L ss
1216A-1000	1000mm	4	25mm (excluding scroll)	190ml	316L ss
1216A-1500	1500mm	5	25mm (excluding scroll)	300ml	316L ss

Additional Tips See page 60 (For rounded or very pointed tips)

Cleaning Brushes See page 177

Storage Cases See page 176

XRF Certification See page 118

Pocket Sampler

Multilevel Sampler for taking discrete samples

Volume 15ml to 90ml per pocket

The Pocket Sampler is used in thousands of pharmaceutical and industrial manufacturing facilities all over the world. The Pocket Sampler is ideal for taking discrete samples from free-flowing powders and granules. This sampler is available in a range of sizes and designs.

Its robust stainless steel design means it will give years of service.

Operation:

1. Insert the sampler into the product
2. At the required depth rotate handle to expose the collecting pockets, the product will flow into the collecting pockets
3. Rotate handle to close pockets and remove sampler
4. See below for details on how to empty the sampler

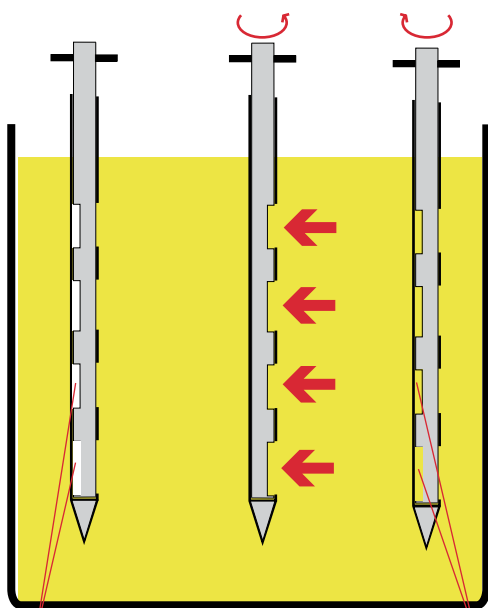

Empty Pockets

Product Flows into Pockets

Sample in Pockets



Emptying Rack (1220R-1)

- The easy and efficient way to empty Pocket Samplers
- Powder samples are dropped into collecting bottles
- 316L stainless steel product contact parts
- Includes stainless steel funnels and sample collection bottles

How many Emptying Racks do I need?

- Not suitable for 300mm samplers
- 600mm and 900mm samplers = 1 rack
- 900mm, 1500mm and 2000mm samplers = 2 racks

New



1220J-900 Pocket Sampler on an Emptying Rack (1220R-1)

Note: Sampler and Emptying Rack are sold separately

Bayonet Handle

- Easy to use
- Quick disconnect system so sampler can be dismantled in seconds.
- Robust design

(Bayonet handle is available on the 1220A and 1220B models)



Sealing Sleeves

- Enables one pocket to be emptied at a time
- Simply clip on to cover the pockets that you do not want to empty
- Easy to remove
- Reusable



Tips

- Samplers are supplied with pointed tips as standard
- Rounded or very long pointed tips are available as an option



1220J-900

Part No.	Outer Tube	Inner Rod	Outer Diameter	Number of Pockets	Volume of each Pocket	Nominal Sampler Length
1220A-600	316L stainless	PTFE	25mm	3	15ml	600mm
1220A-900	316L stainless	PTFE	25mm	3	20ml	900mm
1220A-1500	316L stainless	PTFE	25mm	5	20ml	1500mm
1220B-300	316L stainless	316L stainless	25mm	3	10ml	300mm
1220B-600	316L stainless	316L stainless	25mm	3	15ml	600mm
1220B-900	316L stainless	316L stainless	25mm	3	20ml	900mm
1220B-1500	316L stainless	316L stainless	25mm	5	20ml	1500mm
1220J-900	316L stainless	316L stainless	40mm	3	90ml	900mm
1220J-1500	316L stainless	316L stainless	40mm	4	90ml	1500mm
1220J-2000	316L stainless	316L stainless	40mm	4	90ml	2000mm

Accessories	
8005A-01	Sealing Sleeve Set - Covers pockets - set of 3 sleeves (25mm diameter - suitable for 1220A and 1220B)
8005A-02	Sealing Sleeve Set - Covers pockets - set of 3 sleeves (40mm diameter - suitable for 1220J)
1220R-1	Emptying Rack (includes 3 x funnels and 3 x 250ml bottles)
8185P-250	Spare Bottles for Emptying Rack 250ml - Box of 100 bottles
Additional Tips	See page 60 (for rounded or very pointed tips)
Cleaning Brushes	See page 177
Storage Cases	See page 176
XRF	Material certification verified by XRF (See page 118)

Mono Pocket Sampler

Single Point Zone Sampler

Volume 20ml

The Mono Pocket Sampler is ideal for taking bulk samples from a single point. It is suitable for sampling free-flowing powders and granules.

The robust body is made from 316L stainless steel and is available in 3 lengths.

- For sampling free-flowing powders
- Chemically resistant 316L stainless steel construction
- Easy clean design
- Fast delivery anywhere in the world (available from stock)

Operation

The Mono Pocket Sampler is quick and easy to use:

1. Close the sampler by turning the handle.
2. Push into the powder/granules
3. Rotate the handle to open the sampler
4. Close the sampler by rotating the sampler
5. Remove the sampler
6. Transfer sample to bottle or bag



Part No.	Nominal Length	Nominal Sample volume	Sampler Diameter	Material
1430S-600	600mm	20ml	25mm	316L stainless steel
1430S-1000	1000mm	20ml	25mm	316L stainless steel
1430S-1500	1500mm	20ml	25mm	316L stainless steel
Additional Tips	See page 60 (For rounded or very pointed tips)			
Cleaning Brushes	See page 177			
Storage Cases	See page 176			
XRF Certification	See page 118			

Additional Tips

Interchangeable tips for stainless steel samplers

Many stainless steel samplers are available with interchangeable tips. Choose the best tip for your product and equipment.

Samplers are supplied with a Standard Tip.

- Standard Tip** Ideal for use with most powders
- Pointed Tip** Use with hard, dense powders
- Rounded Tip** Use when you need to minimise the risk of damaging your equipment



Part No.	Description	To Suit Sampler Diameter	Material
TIP-25A	Standard Tip - 25mm	25mm	316L ss
TIP-25R	Rounded Tip - 25mm	25mm	316L ss
TIP-25P	Long Pointed Tip - 25mm	25mm	316L ss
TIP-40A	Standard Tip - 40mm	40mm	316L ss
TIP-40R	Rounded Tip - 40mm	40mm	316L ss
TIP-40P	Long Pointed Tip - 40mm	40mm	316L ss

Sleeve Sampler

Large Volume Sampling From depth

Volume 100ml to 200ml

The Sleeve Sampler is ideal for sampling large volumes at depths up to 6m (20 feet). It is suitable for sampling free-flowing powders and granules.

Various sized chambers can be attached to the same handle to allow different sample volumes to be taken. Extension rods are used to increase the length of the sampler.

- Single Point Sampler
- Suitable for sampling free-flowing powders
- 316L stainless steel, bright finish
- Adjustable Length - use extension rods to make the sampler the length you require

The heavy duty handle and extension rods have been designed to be extremely strong and robust to allow samples to be taken from depths up to 6m (after about 6m the sampler becomes too heavy).



Operation:

1. Screw the Sample Chamber onto the handle and insert the sampler into the product.
2. At the required depth pull up the sampler slightly. This will force the sleeve down so that product can fall into the Sample Chamber.
3. Remove sampler.
4. To empty sampler either pour sample out of filling port or unscrew the tip.

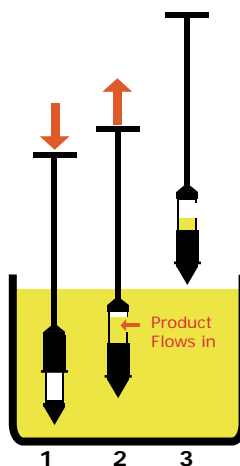

Powders Single Level Sampling

Use extension rods (1035E-1000 or 1035E-1500) to increase the reach of the sampler

Handles & Extension Rods		
Part No.	Description	Length
1035A-1000	Heavy Duty Handle - 316L ss	1070mm
1035A-1500	Heavy Duty Handle - 316L ss	1580mm
1035E-1000	Heavy Duty Extension Rod - 316L ss	1015mm
1035E-1500	Heavy Duty Extension Rod - 316L ss	1525mm

Sample Chambers		
Part No.	Material	Nominal Volume
1035T-100	316L ss	100ml
1035T-150	316L ss	150ml
1035T-200	316L ss	200ml

Storage Cases	See page 176
XRF Certification	See page 118

Jumbo Sack Sampler

Wide diameter Sack Samplers

Our new range of Jumbo Sack Samplers have been introduced to meet the demand of sampling larger items such as nuts, grains and larger granules from sacks.

The Jumbo sack samplers are available in 2 lengths and 3 different styles:

- Suitable for sampling free-flowing powders and granules
- Plain style - Simply hold over a bag
- End Cap - The sample is held in the sampler until the sample is deposited
- Bottle adapter - Sample drops straight into the bottle

Note: 1309C-400 and 1309C-800 are supplied with a 1000ml sample bottle Spare Bottle Part No: 8126H-1000 (see page 188)



Part No.	Length	Diameter	End Fitting	Material
1309A-400	400mm	40mm	Plain	316L ss
1309B-400	400mm	40mm	End Cap	316L ss
1309C-400	400mm	40mm	Bottle Adapter	316L ss
1309A-800	800mm	40mm	Plain	316L ss
1309B-800	800mm	40mm	End Cap	316L ss
1309C-800	800mm	40mm	Bottle Adapter	316L ss



Disposable Sack Sampler

Pre-Sterilised Disposable Samplers

The disposable Sack Sampler is a hygienic, single use device that has been specially designed to take samples through the side of a sack.

- Suitable for sampling free-flowing powders and granules
- Individually Bagged
- FDA & EU 10/2011 Conforming Materials
- BSE/TSE Free
- Full Batch Traceability
- Available Sterile (gamma irradiated) & non-sterile

Operation:

1. Insert the sampler through the side of the sack.
2. Angle sampler downwards to allow the product to flow into the sample collecting bag
3. Seal the hole with an Ultra Adhesive label (see pages 180-186)



Part No.	Length	Diameter	Sterile	Box Quantity
8085A-100	400mm	25mm	No	100
8085A-100S	400mm	25mm	Yes	100
8080A-450	Sample Collecting Bag 450ml - for hygienic use - sterile			Quantity: 1000 bags
8080A-900	Sample Collecting Bag 900ml - for hygienic use - sterile			Quantity: 1000 bags



Sack Master

The World's Best Range of High Quality Sack Samplers



The Sampling Systems Sack Master range has been specially designed to take samples through the side of a sack.

A unique range of sample collection methods are available.

- Single point sampler
- Suitable for sampling free-flowing powders and granules
- 316L stainless steel or HDPE

Operation:

1. Insert the sampler through the side of the sack.
2. Angle sampler downwards to allow the product to flow into the sample collecting container
3. Seal the hole using an Ultra Adhesive label (see pages 180-186).

A. Sack Sampler with Plain End

- Sample collecting bag is held over end of sampler
- Plain end

Part No.	Length	Diameter	End Fitting
1320A-01	400mm	25mm	Plain



B. Sack Sampler with End Cap

- Cap screws on to end of Sack Sampler
- Easily removed for cleaning
- Sample is retained in Sack Sampler

Part No.	Length	Diameter	End Fitting
1320B-01	420mm	25mm	End Cap



C. Sack Sampler with Bottle Adapter

- Adapter screws on to end of Sack Sampler
- Sample is collected in either a 250ml or 500ml bottle
- After sampling unscrew bottle and screw on the plastic bottle cap

Part No.	Length	Diameter	End Fitting
1320C-01	420mm	25mm	Bottle Adapter*

* Supplied with 1 x 250ml Sample Bottle (Part no. 8165A-250)

Spares

8165A-250	250ml Bottle HDPE
8165A-500	500ml Bottle HDPE



Use Ultra Adhesive Labels to seal the sacks after sampling.

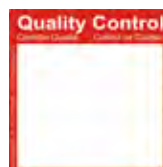

See the full range of labels on pages 180 to 186

Stainless Spoons 316L ss

Long Handled Spoons

Volume 10ml

- 316L stainless steel construction
- Crevice free
- Bowl & flat ends
- Satin finish
- 10ml Volume



Part No.	Nominal Bowl Volume	Nominal Length	Material
A506-300	10ml	300mm	316L ss
A506-600	10ml	600mm	316L ss
A506-1000	10ml	1000mm	316L ss

See Pages 156 to 161 for our complete range of Spoons

Measuring Scoop

Accurately Measures Powders

Volume 1ml to 50ml

New
Sizes

Measuring Scoops are ideal for measuring fixed volumes of powder. They are made from high quality 316L stainless steel.

The scoops are available in a range of sizes with special volumes available on request.

Part No.	Volume of Scoop	Material of Construction
1900A-01	1ml	316L ss
1900A-03	3ml	316L ss
1900A-05	5ml	316L ss
1900A-10	10ml	316L ss
1900A-25	25ml	316L ss
1900A-50	50ml	316L ss



The world's **largest** range of stainless steel scoops

See pages 140-145 for more information

Point Sampler

Large Volume Sampling from a set point

Volume 100ml to 500ml

The Point Sampler from Sampling Systems is ideal for taking samples at a specified depth. The samplers are available in several lengths and with a 100ml or 500ml sample volume.

Point Samplers can be used for sampling both free-flowing and sticky, cohesive powders.

After use the samplers can be quickly stripped down and cleaned.

- Large 100ml or 500ml sample size
- 316L stainless steel construction.
- Suitable for use with free-flowing and cohesive powders

Operation

1. Ensure the sampling window is closed and then push sampler into the product to the required sampling depth
2. Rotate sampler through 360° - this will open the sampling window and push the surrounding product into the sample collecting chamber
3. Rotate the sampler backwards through 360° to close the sampling window
4. Withdraw the sampler



Powders Single Level Sampling

New sizes

Part No.	Handle Length	Nominal Sample Volume	Material
1640A-1000	1000mm	100ml	316L stainless steel
1640A-1500	1500mm	100ml	316L stainless steel
1640A-2000	2000mm	100ml	316L stainless steel
1985A-1000	1000mm	500ml	316L stainless steel
1985A-1500	1500mm	500ml	316L stainless steel
1985A-2000	2000mm	500ml	316L stainless steel

Telescopic Powder Sampler

Take Powder Samples up to 6m Deep

Volume 1ml to 200ml

The Telescopic Powder Sampler is designed for use with free-flowing powders, granules and grains. The handle can be quickly and easily extended to the desired length. The Telescopic Powder Sampler enables samples to be quickly and easily taken from depths of up to 6m.

- Telescopic rod extends up to 6m
- Range of different sized sample collecting Chambers
- 316L stainless steel construction with PTFE clutch

Operation

1. Insert sampler into the product.
2. This action forces the sleeve upwards covering the sample hole and stopping powder from entering.
3. On pulling the sampler upwards, the sleeve moves down and the product can now enter the sampler.
4. Withdraw the sampler
5. Pull sleeve back to discharge powder

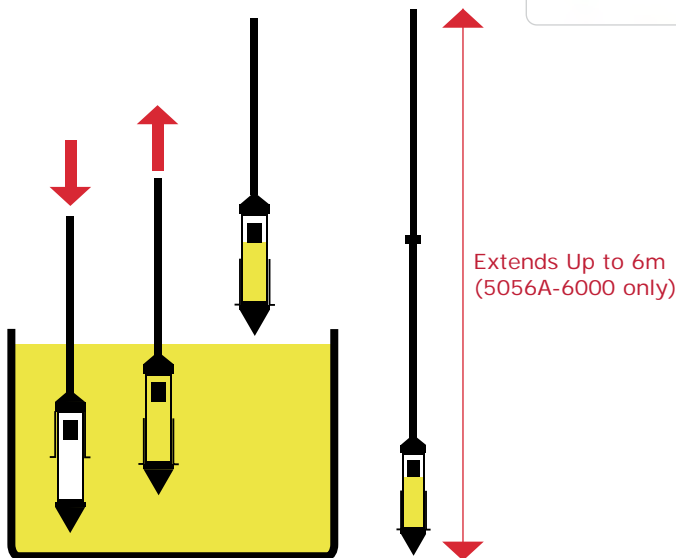

Telescopic sampler ideal for sampling at large depths

Powders Single Level Sampling

Telescopic Handles

Part No.	Length	Material of Construction
5065S-1500	820 to 1500mm	316L stainless steel & PTFE
5065S-3000	1530 to 3000mm	316L stainless steel & PTFE
5065S-4500	1580 to 4500mm	316L stainless steel & PTFE
5065A-1201	750 to 1200mm	Aluminium & Plastic
5065A-2501	1370 to 2500mm	Aluminium & Plastic
5065A-2801	1050 to 3000mm	Aluminium & Plastic
5065A-3001	1235 to 3000mm	Aluminium & Plastic
5065A-4501	1720 to 4500mm	Aluminium & Plastic
5065A-6001	18450 to 6000mm	Aluminium & Plastic
Storage Cases	See page 176	
XRF Certification	See page 118	

Sample Chambers

Part No.	Chamber Volume	Material
1035P-001	1ml	316L stainless steel
1035P-002	2ml	316L stainless steel
1035P-100	100ml	316L stainless steel
1035P-150	150ml	316L stainless steel
1035P-200	200ml	316L stainless steel

Special volumes available on request.

Powder Max

Large volume sleeve sampler

Volume 150ml

Designed for use with free-flowing powders, granules and grains. The Powder Max enables large samples to be quickly and easily taken.

The Powder Max is made from 316L stainless steel.

- Large 150ml sample size
- 316L stainless steel
- Suitable for use with free-flowing powders and granules

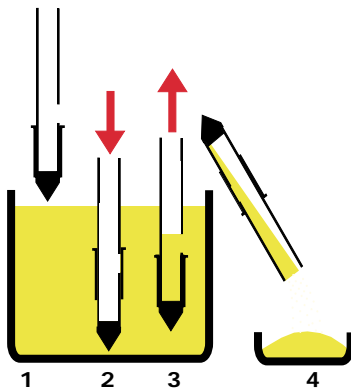

Operation

1. Insert sampler into the product.
2. This action forces the sleeve upwards covering the sample hole and stopping powder from entering.
3. On pulling the sampler upwards, the sleeve moves down and the product can now enter the sampler.
4. Invert sampler to discharge the sample.



Part No.	Nominal Length	Max. Sample Volume	Max. Diameter	Material
1213A-01	1040mm	150ml	52mm	316L ss
Accessories	Cleaning Brushes	See page 177		
	Storage Cases	See page 176		
	XRF Certification	See page 118		

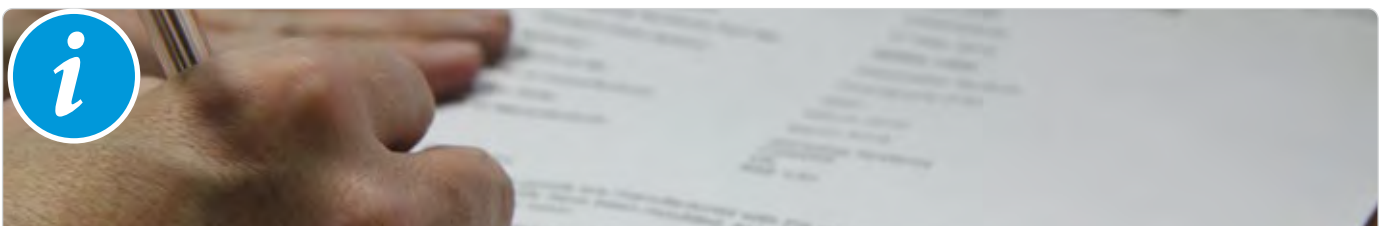

Do You Need Specification Sheets?

Specifications sheets for every product can now be downloaded from www.sampling.com

MicroThief

Ultra Low Volume Powder Thief

Volume 0.01 to 0.1ml

The MicroThief is suitable for taking very small volume samples of free-flowing powders and granules. The MicroThief is easily adjusted so that the operator can vary the size of the sample being taken.

- Made from high quality 316L stainless steel
- Adjustable - takes a range of sample sizes
- Easy to use

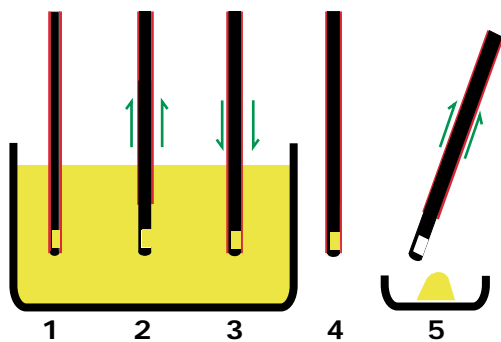

Operation

1. Insert the sampler into the product, ensure that the tip is inside the sampler body.
2. At the required depth pull up the body to expose the tip. Powder will flow in around the tip.
3. Push down body of the sampler to trap the sample.
4. Withdraw sampler.
5. Pull up body to release the sample.



Part No.	Nominal Sample Volume	Max. Sampling Depth	Outer Diameter of Sampling Tube	Material
1074A-350	Adjustable between 0.01 and 0.1ml	350mm	5mm	316L ss
1074A-500	Adjustable between 0.01 and 0.1ml	500mm	5mm	316L ss

Storage Cases See page 176

XRF Certification See page 118

MicroMate

Ultra Low Volume Powder Sampler

Volume 0.01 to 0.1ml

The MicroMate is designed for low volume sampling of free-flowing powders and granules. It is ideal for very low volume unit dose sampling.

The MicroMate can be easily adjusted so that it can take a range of sample sizes.

- Made from high quality 316L stainless steel
- Adjustable - takes a range of sizes
- Easy to use

Operation

1. Insert the sampler into the product. Ensure that the inner rod extends beyond the outer tube.
2. At the required depth pull up the inner rod to draw the product into the sampler.
3. Withdraw sampler.
4. Push down handle to release sample

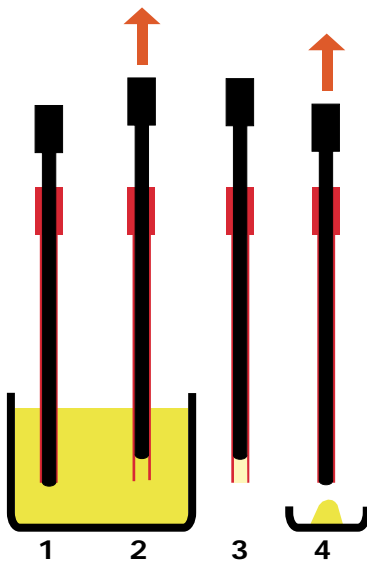

Powders
Single Level Sampling



Part No.	Nominal Sample Volume	Max. Sampling Depth	Outer Diameter of Sampling Tube	Material
1070A-350	Adjustable - up to 0.1ml	350mm	5mm	316L ss
1070A-500	Adjustable - up to 0.1ml	500mm	5mm	316L ss

Storage Cases See page 176

XRF Certification See page 118

Unit Dose Sample Thief

Unit Dose Sampling made easy

The Unit Dose Sample Thief is a highly versatile sampler for taking multiple samples at multiple heights within the product.

The operator can quickly change the sample volume and the number of samples taken by simply changing the inner rod.

- Multilevel Unit Dose Sampling
- Ideal for sampling free-flowing powders and granules
- Take one, two or three samples at each sampling height
- 316L stainless steel



Above - Triple Style Sampler

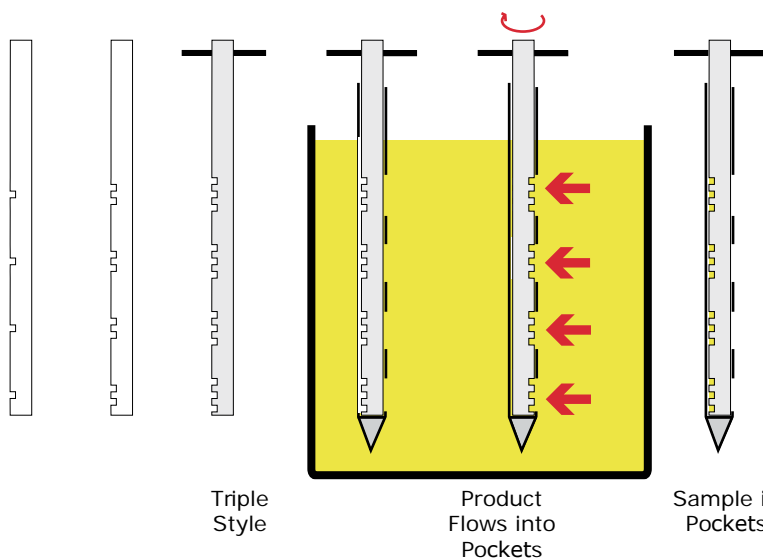

Operation:

1. Select the correct Inner Rod and fit it inside the Outer Tube
2. Insert the sampler into the product, turn the handle to expose the pockets to the product.
3. Turn the handle to the original closed position, then remove the sampler from the product.
4. Remove the Inner Rod from the Outer Tube to expose the samples.

Note:
Maximum sample volume is 3ml per pocket

Ordering -

This sampler is custom made to your requirements.

To place an order let us know:

- Length of sampler
- Number of sampling positions
- Number of samples to be taken at each sampling position (Do you require a Single, Double or Triple style sampler?)
- Volume of each sample

Please contact us to discuss your requirements.

Sample Containers

For a complete range of sample bottles and containers please see pages 188-210.

Ideal for sample transportation and storage.



U-D Sleeve Sampler

The Accurate Unit Dose Powder Sampler

Volume 0.1 to 2.5ml

The U-D Sleeve Sampler is extensively used in the pharmaceutical industry for accurate, small volume sampling of free-flowing powders and granules. It is ideal for Unit Dose Sampling.

- Single Point Unit Dose Sampler
- Suitable for use with free-flowing powders and granules
- 316L stainless steel
- Use extension rods to increase the length of the sampler

Operation

1. Insert the sampler into the product.
2. At the required depth pull up the sampler slightly (this upwards action will force the sleeve down the sample chamber and expose the ports) the product can then fall into the sample chamber.
3. As the sampler is removed the excess powder will fall out of the overflow leaving an accurate volume of powder in the sample chamber.



U-D Sleeve Sampler Set (1500S-01) - The set includes a range of 10 interchangeable tips to allow different sample volumes to be taken. Extension rods allow samples to be taken from a depth of up to 3m.

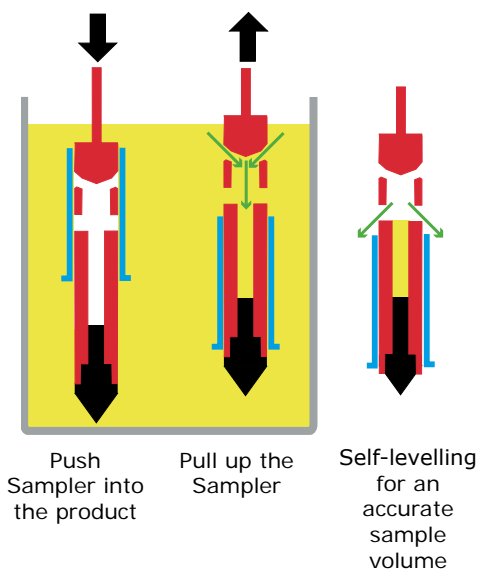

Different Volume Sampling Tips can be fitted to the same chamber



Powders Single Level Sampling

Part No.	Description
1500S-01	U-D Sleeve Sampler Set Includes: 1 x T-bar handle - 600mm 4 x handle extension rods - 600mm 1 x Type 1 sample chamber (for Tips 0.1 to 1.2ml)
	1 x Type 2 sample chamber (for Tips 1.3 to 2.5ml) 10 x Sampling tips* (0.1ml to 2.5ml - see below) 1 x High Quality Sampler Case - lockable
1500A-01	T Bar Handle 600mm
1500A-02	Handle Extension 600mm
1500A-03	Sample Chamber - Type 1 (for Tips 0.1 to 1.2ml)
1500A-04	Sample Chamber - Type 2 (for Tips 1.3 to 2.5ml)
1500C-01	High Quality Sampler Case - lockable - with cut outs for sampler components
XRF Certification	XRF Certification (See page 118)
Sampling Tips	
Tips are available in all sizes from 0.1ml to 2.5ml in 0.1ml increments. (0.1ml, 0.2ml, 0.3ml, 0.4ml etc.)	
How to Order a Tip:	
Use part number	1500W-XX where XX is the tip size
Example:	1500W-07 0.7ml tip 1500W-23 2.3ml tip

* When ordering 1500S-01 please list the 10 sampling tips that you require

U-D Cohesive Sampler

Unit Dose Sampler for Cohesive Powders

Volume 0.25ml to 1.0ml

A popular sampler in the pharmaceutical industry for taking low volume (unit dose) cohesive powder samples. Allows accurate samples to be taken.

- Single Point Unit Dose
- 316L stainless steel
- Suitable for use with sticky, cohesive powders

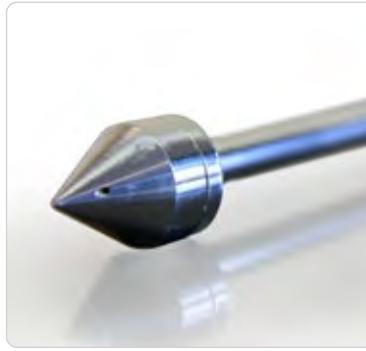

Operation

1. Insert the sampler into the product.
2. At the required depth push down the handle and rotate it through 180°.
3. Pull up sampler slightly (to fill the cell), then rotate handle 180° (to lock cell in closed position).
4. Remove sampler

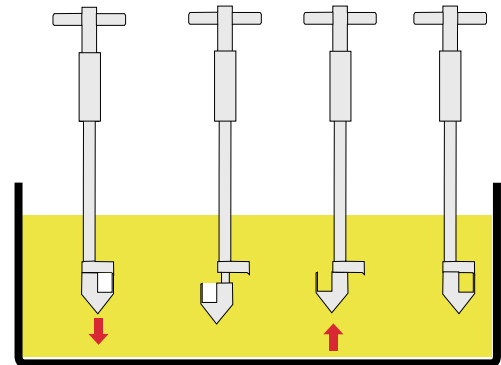

Sample Collecting Cells are available in a range of standard sizes.



2000T-025



2000T-050



2000T-075



2000T-100

Part No.	Description
2000S-01	U-D Cohesive Sampler Set - consisting of: 1 off Handle, Sample Cells - 1 each of: 0.25ml, 0.5ml, 0.75ml and 1.0ml 1 off Standard Sampler Case
2000A-1000	Sampler body with 1000mm handle length - 316L ss
2000T-025	Sample Collecting Cell 0.25ml - 316L ss
2000T-050	Sample Collecting Cell 0.5ml - 316L ss
2000T-075	Sample Collecting Cell 0.75ml - 316L ss
2000T-100	Sample Collecting Cell 1.0ml - 316L ss
8020N-1100	Storage Cases - See page 176
	XRF Certification - See page 118

Multi Thief

Multilevel Powder Sampler with variable Sample Volumes

Volume 5ml to 60ml

The Multi Thief is ideal for taking multilevel samples from free flowing powders and granules.

The sample volume can be quickly and easily changed by swapping the removable sample cells.

- 316L stainless steel construction
- Variable sample volumes 5ml to 60ml
- Range of sampler lengths
- Suitable for free-flowing powders and granules



Operation:

1. Select the correct volume inserts and fit them into the inner rod.
2. Slide the assembled inner rod into the outer tube
3. Insert the sampler into the product, turn the handle to expose the sampling cells to the product.
4. Turn the handle so no sampling inserts are exposed then remove the sampler from the product.
5. Remove the inner rod from the outer sleeve, the individual Sampling Inserts can then be easily removed for analysis.



Inserts are easily removed after sampling

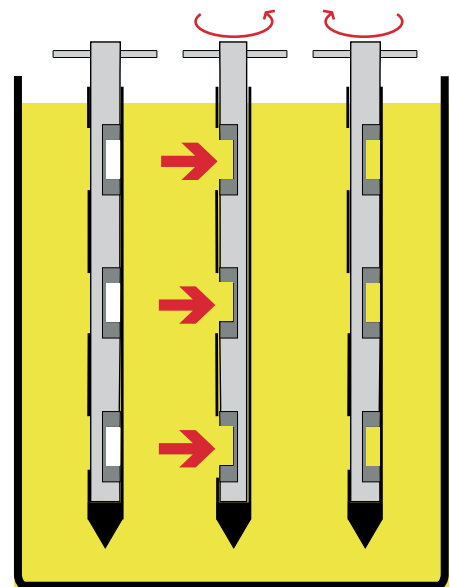

Powders Multi Level Sampling

Part No.	Nominal Length	Diameter	No. of Inserts Required	Material of Construction
1290K-1000	1000mm	40mm	3	316L stainless steel
1290K-1500	1500mm	40mm	4	316L stainless steel
1290K-2000	2000mm	40mm	4	316L stainless steel

Sample Inserts

Inserts are available any volume from 5ml up to 60ml

1290W-XX Sample Insert where XX = sample volume in ml e.g. 1290W-60 = insert with 60ml sample volume.
Note: Standard stock sizes are 5ml, 10ml, 20ml, 25ml, 30ml, 40ml, 50ml, 60ml and blanks. Other sizes are made to order

1290W-00 Blank Insert

Additional Tips See page 60 (For rounded or very pointed tips)

Cleaning Brushes See page 177

Storage Cases See page 176

XRF Certification See page 118

AccuPod® Sampler

Minimise Sampling Error

Volume 1ml to 5ml per pod



The patented AccuPod® is the next generation in sampling technology. It combines a single use, disposable Pod with a reusable stainless steel sample thief.

The AccuPod® is designed to minimise sampling error which can occur when a sample is transferred from one container to another. With the AccuPod® the sample remains in the pod until it is needed in the laboratory.

The AccuPod® is ideal for sampling free-flowing powders and granules.



The AccuPod® is quick and easy to use.

- Insert the Pods into the sample thief
- Take sample
- After sampling click the lids onto the Pods
- Take the Pods to the laboratory
- Slide off the lid to access the sample



On Line Video

To find out more about the AccuPod® please visit

www.sampling.com/accupod

i



It's as easy as 1, 2, 3

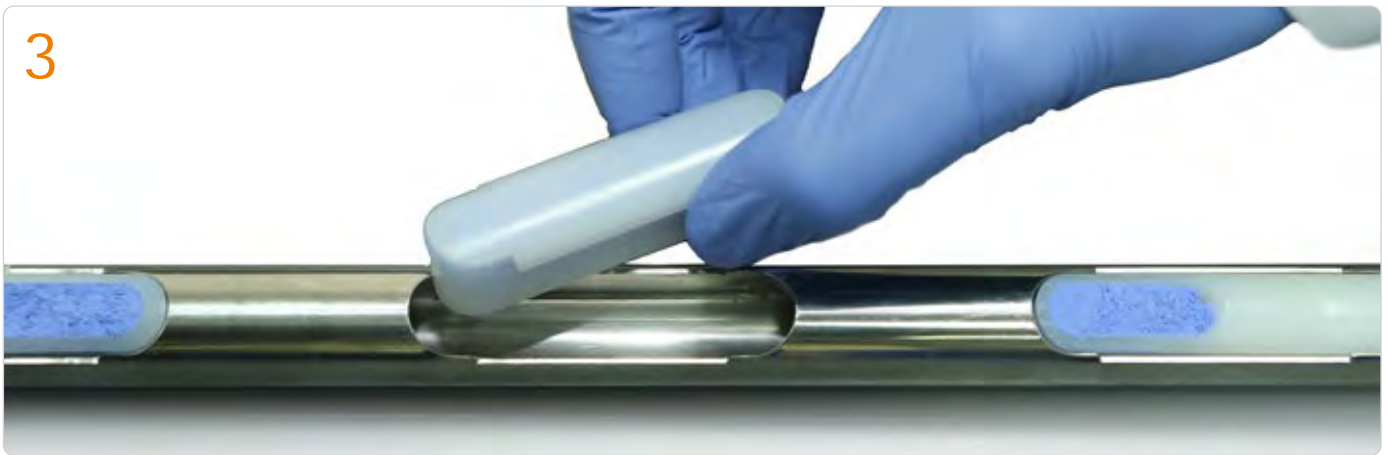
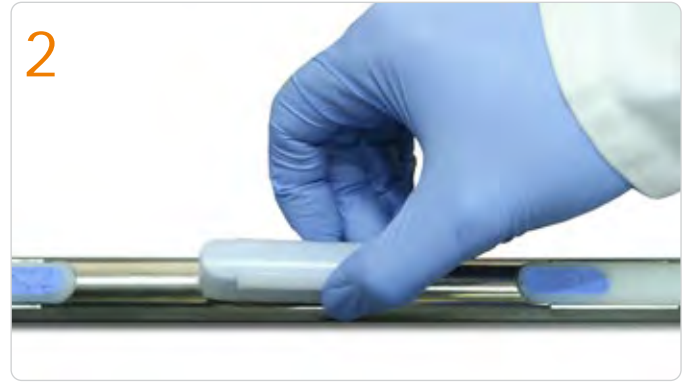

Powders Multi Level Sampling

Pods

- Suitable for use with the AccuPod Sample Thief
- Made from FDA, EU and EC compliant HDPE
- Initially available in 1ml and 5ml sizes. Other sizes to follow - please contact us for details
- Supplied with lid
- Individually bagged
- Made in a Class 8 (class 100,000) Cleanroom
- Available pre sterilised (gamma irradiation)

Part No.	Nominal Volume	Sterile	Material	Quantity per Box
8360T-10	1ml	No	HDPE	50
8360T-10S	1ml	Yes	HDPE	50
8360T-50	5ml	No	HDPE	50
8360T-50S	5ml	Yes	HDPE	50

AccuPod® Sample Thief

- Made from 316L stainless steel
- Available in a range of different lengths
- Available from stock
- 25mm diameter
- Standard samplers have 1 or 3 sampling ports
- Samplers with a bespoke number of ports available on request

Single Port

Part No.	Nominal Sampler Length	Number of Sampling Ports
1360A-301	300mm	1
1360A-601	600mm	1
1360A-1001	1000mm	1
1360A-1501	1500mm	1
1360A-2001	2000mm	1

Triple Port

Part No.	Nominal Sampler Length	Number of Sampling Ports
1360A-303	300mm	3
1360A-603	600mm	3
1360A-1003	1000mm	3
1360A-1503	1500mm	3
1360A-2003	2000mm	3

Accessories		
	Cleaning Brushes	See page 177
	XRF certification	See page 118

UD Master

Unit Dose Sampling to meet FDA Guidelines

Volume 0.1ml to 4ml per pocket

The patented UD Master is designed for multilevel low volume sampling in the pharmaceutical industry. It is ideal for use with free-flowing powders. By simply changing the sample Inserts (cells) different volumes can be sampled.

- Manufactured from 316L stainless steel
- Satin polish (Ra < 1microns)
- Take multiple samples from the same point
- Range of sampler lengths
- Change the sample volume by changing the insert
- Special finishes and materials of construction available on request

Sample Inserts are available in a range of sizes from 0.1ml to 4.0ml, plus blank inserts



More than one sample can be taken from the same sampling point (see double or triple styles).



Single style sampler

Double style sampler

SINGLE Style Sampler

Collects ONE set of samples at each sampling point.

DOUBLE Style Sampler

Collects TWO sets of samples at each sampling point.

TRIPLE Style Sampler

Collects THREE sets of samples at each sampling point.

Operation:

1. Select the correct volume Inserts and fit them into the Inner Rod.
2. Slide the assembled Inner Rod into the Outer Sleeve at the lowest sampling level
3. Insert the sampler into the product, turn the handle to expose the sampling cells to the product.
4. Double and Triple Style samplers - pull the handle to the next level to expose the next set of sampling cells.
5. Turn the handle so no Inserts are exposed then remove the sampler from the product.
6. Remove the Inner Rod from the Outer Sleeve, the individual Inserts can then be easily removed for analysis.

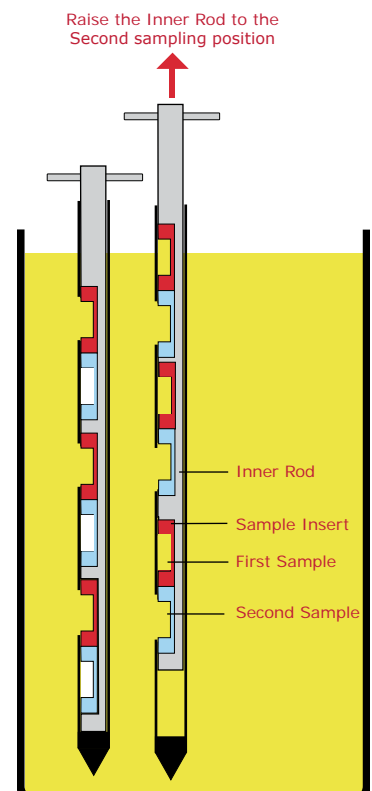

Drawing showing how the Double Style Sampler takes two samples from each sampling point.

Choose the right Inserts to get the required sample



Sample Inserts are marked with their volume for easy identification



	Part No.	Nominal Sampler Length	Sampler Diameter	Number of Sampling Points	No. of Inserts needed
SINGLE Style Sampler	1230A-300	300mm	22mm	5	5
	1230A-600	600mm	22mm	10	10
	1230A-900	900mm	22mm	6	6
	1230A-1200	1200mm	22mm	8	8
	1230A-1500	1500mm	22mm	10	10
	1230A-1800	1800mm	22mm	12	12
DOUBLE Style Sampler	1230B-600	600mm	22mm	5	10
	1230B-900	900mm	22mm	7	14
	1230B-1200	1200mm	22mm	8	16
	1230B-1500	1500mm	22mm	10	20
	1230B-1800	1800mm	22mm	12	24
TRIPLE Style Sampler	1230C-900	900mm	22mm	5	15
	1230C-1200	1200mm	22mm	7	21
	1230C-1500	1500mm	22mm	8	24
	1230C-1800	1800mm	22mm	10	30

Inserts

Inserts are available in 0.1ml increments from 0ml to 4ml. Available from stock.
 Part Number is 1230T-XX (where XX = Cell Volume)
 For Example - The Part Numbers for 1.2ml and 0.5ml Inserts are : 1230T-12 and 1230T-05 respectively
 1230T-00 = Blank Insert

Accessories		
	Cleaning Brushes	See page 177
	Storage Case	See page 176
	XRF certification	See page 118



UD Tablet Maker

After Sampling make a Tablet to reduce Sampling Error

Volume 1ml to 3ml

The UD Tablet Maker is designed to compress the powder samples taken by the UD Master. By compressing the sample it ensures that loose powder is not lost during handling, this helps to reduce sampling error.

Special Split Sample Cells need to be used in place of the standard sample cells. (Note: These inserts will only work with the standard U-D Master)

What Do I Need?

1. The U-D Tablet machine (see table below)
2. Special split samples cells (see table below)
3. The correct tablet punches for the split sample cells (see table below)
4. Sampler - see Standard U-D Master (see pages 76-77)
5. Pressure Gauge 5k or 10k PSI

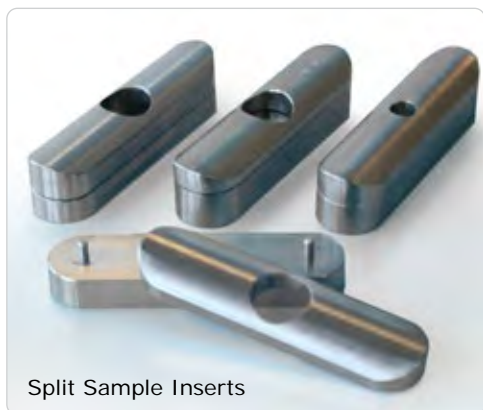

Split Sample Inserts

Part No.	Description
1230TABLET	Tablet Compression Machine - manually operated - Size - 200mm x 400mm x 400mm high

Split Sample Inserts are available in 0.1ml increments from 0 to 3ml.
Part Number is 1230T-XXS (where XX= cell volume)
For example - The Part Number for 1.2ml and 0.5ml respectively are: 1230T-12S and 1230T-05S

1230P-01	Punch for use with 0.1ml split Sample Inserts
1230P-02	Punch for use with 0.2ml split Sample Inserts
1230P-03	Punch for use with 0.3, 0.4, 0.5 and 0.6ml split Sample Inserts
1230P-07	Punch for use with 0.7, 0.8, 0.9, 1.0 and 1.1ml split Sample Inserts
1230P-12	Punch for use with 1.2, 1.3, 1.4, 1.5, 1.6, 1.7, 1.8, 1.9 and 2.0ml split Sample Inserts
1230P-21	Punch for use with 2.1, 2.2, 2.3, 2.4, 2.5, 2.6, 2.7, 2.8, 2.9 and 3ml split Sample Inserts



Over 1 Million Stock Items

At our state of the art warehouse we keep over 1 million items in stock. Stock is controlled by the latest software so we can ship 95% of orders on the day the order is placed.

Maxi-Corer

Surface sampler for powders and granules

The Maxi Corer is suitable for the surface sampling of powders and granules. It can also take core samples.

- 316L stainless steel construction
- Two sizes
- Crevice free
- Satin finish

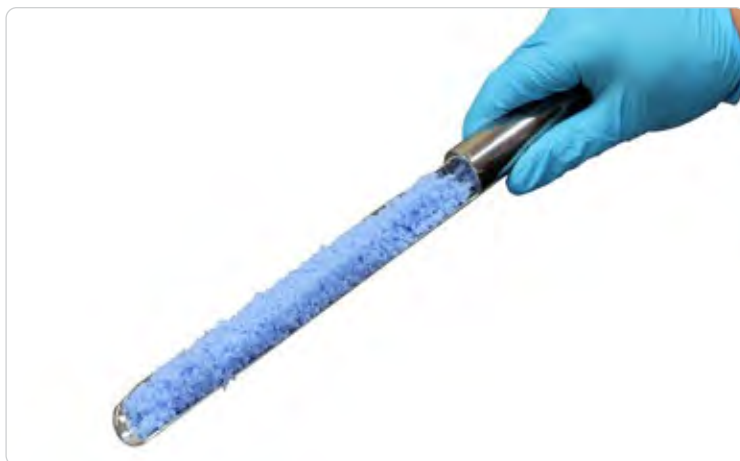

Part No.	Diameter	Overall Length	Scoop Length	Material
7010A-01	25mm	300mm	200mm	316L ss
7010A-02	25mm	600mm	500mm	316L ss

XRF Certification - See page 118

V Spatula

Multi Purpose Powder Spatula

The V Spatula from Sampling Systems is ideal for surface sampling of powders and core sampling of semi-solid materials like cheese, pastes and gels.

The 'V' shape allows easy discharge of the powders into containers or bags.

- 316L stainless steel
- Polished finish
- Fully welded, crevice free construction



Part No.	Blade Width	Overall Length	Blade Length	Material
1095N-150	20mm	233mm	150mm	316L ss
1095N-250	20mm	333mm	250mm	316L ss
1095S-150	25mm	227mm	145mm	316L ss

XRF Certification - See page 118



Powder Lance

Cross Sectional Sampler for Cohesive Powders

Volume 190ml to 520ml

The Powder Lance can be used to take large volume samples of cohesive powders. The sampler can be used horizontally through a sack or it can be used vertically.

The sampler has a built in scraper to push the powder into the sampler.

- Cross sectional sampler
- Made from 316L stainless steel
- Suitable for sticky cohesive powders

Operation:

1. Insert the sampler into the product.
2. Rotate the sampler through 360°. The scraper forces the powder in to the sampler along the length of the slot.
3. Remove the sampler.
4. Unscrew the tip of the sampler.
5. Push the Sample Ejection Rod into the Powder Lance to push out the sample



2250A-600

8570A-700



Part No.	Overall Length	Length of Sampling Slot	Max Sample Volume	Material
2250A-600	630mm	540mm	190ml	316L ss
2250A-1000	1030mm	930mm	300ml	316L ss
2250A-2000	2025mm	1500mm	520ml	316L ss
8570A-700	Sample Ejection Rod - 700mm length (for use with 2250A-600)			316L ss
8570A-1100	Sample Ejection Rod - 1100mm length (for use with 2250A-1000 or 2250A-600)			316L ss

Accessories		
	Cleaning Brushes	See page 177
	Storage Case	See page 176
	XRF certification	See page 118

Cohesive Sampler

Single Point Sampler for Cohesive Powders

Volume 5ml to 25ml

The Cohesive Sampler is able to take a sample from a known point within the product.

- Single Point Sampler
- 316L stainless steel
- Suitable for sticky, cohesive powders

Operation

1. Insert sampler into product ensuring that the sample collecting chamber is in the closed position
2. At the correct sampling depth, turn the inner tube to expose the sample collecting chamber
3. Rotate the entire sampler through 360°. The scraper collects product and guides it into the sample collecting chamber.
4. Turn the inner tube to close the sample collecting chamber
5. Remove sampler
6. Pull out the inner tube and discharge the sample

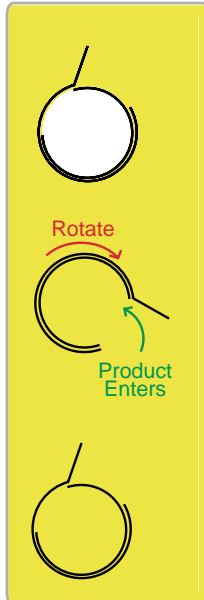

Rotate the whole sampler to take the sample

Close the sampler and withdraw it from the product.

Rotate the inner core to open the sampler



Powders Single Level Sampling

Part No.	Sample Volume	Nominal Length	Sampler Diameter	Material
2015A-05	5ml	1000mm	25mm	316L ss
2015A-10	10ml	1000mm	25mm	316L ss
2015A-25	25ml	1000mm	25mm	316L ss

Accessories		
	Additional Tips (rounded or very pointed tips)	See page 60
	Cleaning Brushes	See page 177
	Storage Case	See page 176
	XRF certification	See page 118

Cohesive Pocket Sampler

Separate samples from distinct heights

Volume 15ml to 20ml

The Cohesive Pocket Sampler has been specially adapted from the Pocket Sampler (on pages 58-59) to enable the taking of samples from damp and cohesive powders. This sampler has separate pockets to give distinct samples from different heights.

Scrapers have been added to push the sticky powder into the sample pockets. Scrapers are fully welded to give a hygienic, GMP correct sampler.

- Multilevel (discrete samples)
- 316L Stainless steel construction
- Suitable for sticky, cohesive powders

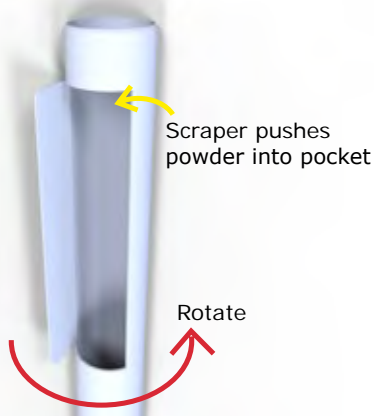

Operation

1. Insert the sampler into the product
2. At the required depth rotate handle to expose the collecting pockets.
3. Rotate the sampler through 360° so the product is pushed into the collecting pockets
4. Rotate handle to close pockets and remove sampler.

Part No.	Nominal Length	Number of Pockets	Nominal Volume of each Pocket	Diameter*	Material
2220B-600	600mm	3	15ml	25mm	316L ss
2220B-900	900mm	3	20ml	25mm	316L ss
2220B-1500	1500mm	5	20ml	25mm	316L ss

Accessories Additional Tips - See page 60 (for rounded or very pointed tips)

Cleaning Brushes - See page 177

Sampler Cases - See page 176

XRF Certification - See page 118

* Diameter does not include scrapers. Scrapers are approximately 10mm high

Cohesive Slot Sampler

Single composite sample

Volume 110ml to 300ml

The Cohesive Slot Sampler has been specially adapted from the popular Slot Sampler (on pages 54-56). Scrapers have been added to push the non flowing powder into the sample slots.

This sampler gives single composite sample that has been taken from a range of heights.

Scrapers are fully welded to give a hygienic, GMP correct sampler.

- Multilevel (composite samples)
- 316L Stainless steel construction
- Suitable for sticky, cohesive powders

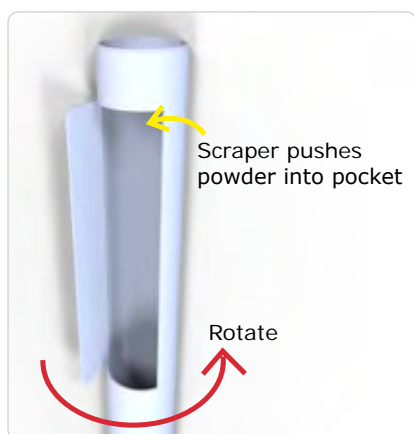
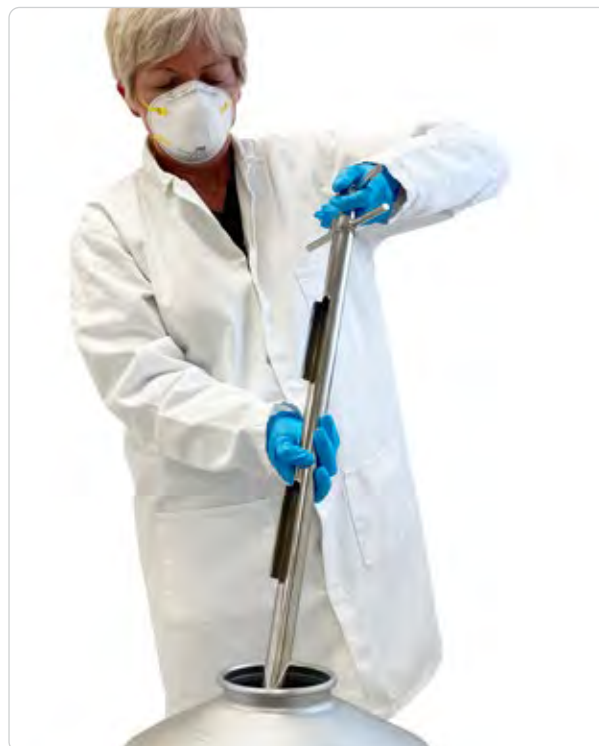

Part No.	Nominal Length	Number of Sampling Slots	Maximum Sample Volume	Diameter*	Material
2210A-600	600mm	3	110ml	25mm	316L ss
2210A-1000	1000mm	4	190ml	25mm	316L ss
2210A-1500	1500mm	5	300ml	25mm	316L ss

Additional Tips - See page 60 (For rounded or very pointed tips)

Cleaning Brushes - See page 177

Sampler Cases - See page 176

XRF Certification - See page 118

* Diameter does not include scrapers. Scrapers are approximately 10mm high

Sample Lance

Cross-sectional Sampling of Sticky Powders



The Sample Lance is ideal for taking cross sectional samples of powders and some pastes. It is manufactured from high quality 316L stainless steel.

The Sample Lance is available with a range of different handles. The Heavy Duty Handle is ideal when the powder is hard and dense. They give additional leverage when the sampler is pushed into the product. Sample Lances can be supplied without handles when the powder is light and fluffy. Heavy Duty handles are suitable for all other applications.

Easy to use. Just push the sampler into the powder to take a core sample.

- Made from 316L stainless steel
- Available in different sizes and handle combinations
- Available from stock

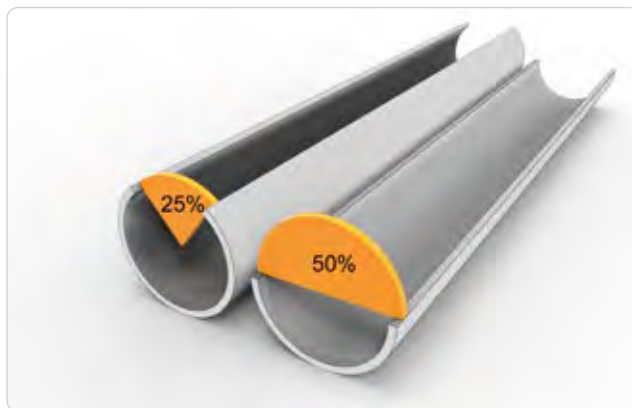

Part No.	Length	Lance Opening Size	Handle Type	Width	Material
1660P-600	600mm	25%	Plain	25mm	316L ss
1660P-1000	1000mm	25%	Plain	25mm	316L ss
1665P-400	400mm	50%	Plain	25mm	316L ss
1665P-600	600mm	50%	Plain	25mm	316L ss
1665P-1000	1000mm	50%	Plain	25mm	316L ss
1660H-600	600mm	25%	Heavy Duty	25mm	316L ss
1660H-1000	1000mm	25%	Heavy Duty	25mm	316L ss
1665H-600	600mm	50%	Heavy Duty	25mm	316L ss
1665H-1000	1000mm	50%	Heavy Duty	25mm	316L ss

Cleaning Brushes - See page 177

Sampler Cases - See page 176

XRF Certification - See page 118

Multilevel Tablet and Capsule Sampler

Tablet and Capsule Sampler

Volume 3 x 20ml

The Multilevel Tablet and Capsule Sampler is suitable for taking a multilevel sample of tablets as the tablet receiving container is filled. The sampler should be placed in the collecting bin at the start of the production run. As the bin fills with tablets the Sampler will automatically take a sample from across the production run.

The sampler is available with either removable sampling cups or with sampling cups that have been welded to the frame.

The sampler has a hooked handle so it can be hooked over the rim of the container.

Operation

1. Hang the sampler on the side of the container.
2. As the container is filled the sampling cups will also fill.
3. When the container is full the sampler can be pulled out.



Part No.	Cup Volume	Number of Sampling Cups	Cup Type	Cup Material	Frame Material
4000A-01	20ml	3	Removable	304 Stainless Steel	316L Stainless Steel
4000A-02	20ml	3	Fixed	304 Stainless Steel	316L Stainless Steel

Multilevel Tablet Sampler

Tablet and Capsule Sampler

Volume 2.1L

The Multilevel Tablet Sampler is suitable for taking a multilevel sample of tablets as the tablet receiving container is filled. The sampler should be placed in the collecting bin at the start of the production run. As the bin fills with tablets the Sampler will automatically take a sample from across the production run.

The Multilevel Tablet Sampler is also suitable for use with capsules.

The Multilevel Tablet Sampler is made from corrosion resistant electro-polished 316L stainless steel.

- Made from 316L stainless steel
- Electro-polished
- Cross sectional sample
- Easy to empty through the bottom of the sampler



Part No.	Overall Length	Sampling Heights	Nominal Max. Sample Volume	Number of Sampling Points	Material
4010B-01	1275mm	70, 270, 475, 675 & 880mm	2.1 L	5	316L Stainless Steel

FreeGlide®

The only In-Line Powder Sampler guaranteed not to jam



The FreeGlide is a patented in-line powder sampler. It is designed to be installed in a vertical pipe and to take samples as the powder fall down pipe. The FreeGlide has a number of innovative features that make it ideal for use in the food and pharmaceutical industries.

FreeGlide Features

- The sample is collected in a cup and so is not physically altered by the sampling process
- In between taking samples the full bore of the pipe is available for product flow
- Product contact parts are either 316L stainless steel or FDA acceptable polymers
- Available with manual or automated operation
- Available in a range of standard sizes
- Quickly dismantles for cleaning between batches



Powders



FreeGlide® samplers are available to suit different pipe diameters and can be either manually or pneumatically operated

Diaphragms

At the heart of the FreeGlide is our patented diaphragm. The diaphragm is made from a flexible polymer and it separates the product area from mechanical area. The diaphragm ensures that powder and dust does not enter the bearings and this keeps the sampler from jamming during use.

Diaphragms are available in three FDA acceptable polymers (silicone, Viton and EPDM).



Silicone (Blue)
Silicone (White)
EPDM (Black)
Viton (Green)

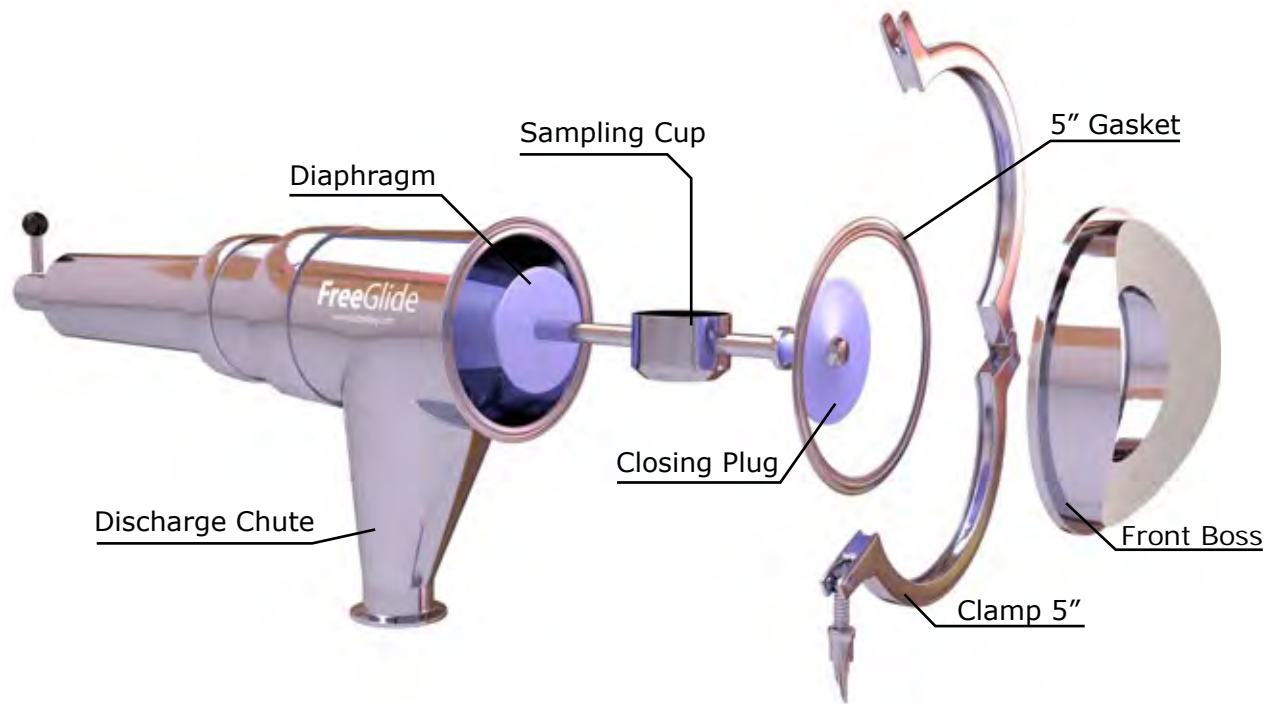

Operation

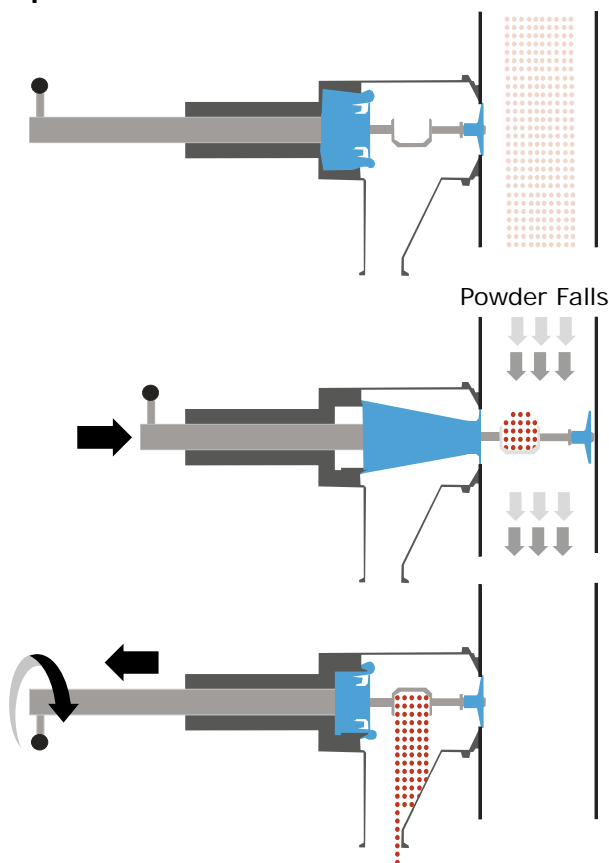

Resting

When the FreeGlide is not in use the full bore of the downpipe is available for powder flow.

In this position the Closing Plug seals the front of the FreeGlide and the diaphragm is automatically folded out of the way.

Sampling

The sampling cup is extended into the downpipe to catch the product as it falls.

In this position the Diaphragm is fully extended so that it seals the FreeGlide from the downpipe.

Discharging

The sampling cup is then retracted and inverted. The powder sample falls down the discharge chute to where it is collected.

In this position the Closing Plug seals the front of the FreeGlide and the diaphragm is automatically folded out of the way.

Materials of Construction

- | | |
|--------------------|--|
| Contact parts: | <ul style="list-style-type: none"> • 316L stainless steel • Silicone rubber, Viton or EPDM |
| Non contact parts: | <ul style="list-style-type: none"> • 304 grade stainless steel • Other materials as required |
| Operation: | <ul style="list-style-type: none"> • Manual or Pneumatic actuation |



On Line Video

To see how easy it is to use the FreeGlide please visit

www.sampling.com/FreeGlide.html

Download the full brochure at: www.sampling.com/brochures

Sampler Stand

Keep samplers clean when not in use



Keep your samplers off the work bench with a Sampler Stand. Sampler Stands are made from 316L stainless steel and can be used with any sampler up to 35mm in diameter.

- Made from 316L stainless steel
- Supplied as a set of 2 stands
- Suitable for use with samplers up to 35mm in diameter



Note: Sampler sold separately

Part No.	Description	Max. Diameter of Sampler	Material
A256-05	Sampler Stand (1 pair of stands)	35mm	316L stainless steel

Earthing Lugs



- Extra cost option for any stainless steel item such as a scoop, sampler or container etc...
- Provides a convenient connection point for earthing (grounding) wires
- Ideal when working with flammable solvents or in ATEX rated environments
- Earthing lugs can be welded to almost any stainless steel device

Part No.	Description
LUG-1	Earthing Lug - 316L stainless steel



Certificates & Specifications are all available to download

Visit our website to download Certificates of Conformity, Certificates of Irradiation and Specification Sheets. Additional documentation is available on request.

For more information please visit: www.sampling.com

Liquid Samplers



Liquid Master

Ideal for Sampling Low & Medium Viscosity Liquids

Volume Up to 1500ml

New sizes

The Liquid Master is ideal for taking samples from low and medium viscosity liquids. It is available in a range of lengths and diameters to give a wide range of sample volumes.

The Liquid Master is easy to use and is designed to be quickly stripped down for cleaning.

Liquid Samplers



Operation:

Technique 1 - Point Sampling

Insert the sampler. Press the push button to take the sample. Remove the sampler.

Technique 2 - Cross Sectional

Press the Push Button and then slowly insert the sampler into the product. As the sampler is pushed in a cross sectional sample is taken. Release the push button at the required depth to stop any more liquid from entering the Sampler. Remove the sampler.

NB. To take a large sample the sampler needs to be inserted deep into the product.

Technique 1

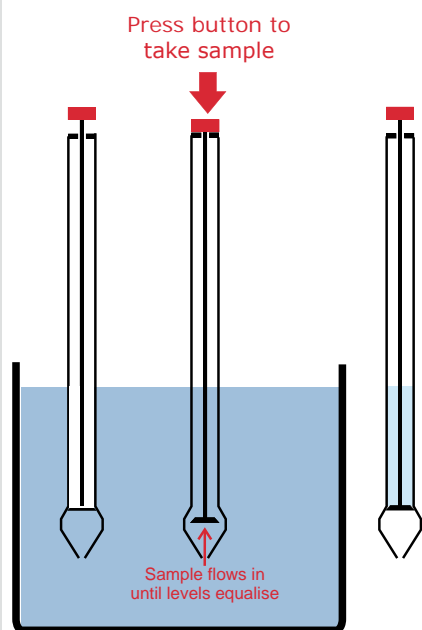



Liquid Samplers

Part No.	Product Contact Material	Length	Maximum Sample Volume	Max. Diameter
5035S-600	316L stainless steel & silicone O-ring	600mm	150ml**	25mm
5035S-1000	316L stainless steel & silicone O-ring	1000mm	270ml**	25mm
5035S-1500	316L stainless steel & silicone O-ring	1500mm	420ml**	25mm
5035S-2000	316L stainless steel & silicone O-ring	2000mm	500ml**	25mm
5035T-601	PTFE/FEP	600mm	150ml**	32mm
5035T-1001	PTFE/FEP	1000mm	270ml**	32mm
5035T-1501	PTFE/FEP	1500mm	390ml**	32mm
5035T-2001	PTFE/FEP	2000mm	510ml**	32mm
5035T-2501	PTFE/FEP	2500mm	660ml**	32mm
5035P-600	Polypropylene	735mm	150ml**	33mm
5035P-1000	Polypropylene	1135mm	270ml**	33mm
5035P-2000	Polypropylene	2135mm	420ml**	33mm
5035J-1000	PTFE/FEP	1060mm	500ml*	38mm
5035J-1500	PTFE/FEP	1565mm	1000ml*	38mm
5035J-2000	PTFE/FEP	2055mm	1500ml*	38mm

Accessories	Cleaning Brushes - See page 177
	Storage Cases - See page 176
	XRF Certification - See page 118

*A 5ml sample will be taken for every 10mm the Liquid Master is inserted into the product
 **A 3ml sample will be taken for every 10mm the Liquid Master is inserted into the product

Pump Samplers



Pump Samplers allow the liquids to be simply and quickly sampled. The only product contact parts are the dip tube and the sample collecting bottle.

The chance of cross contamination is greatly reduced by using new dip-tube and bottles for each sample.

- Suitable for use with low to medium viscosity liquids.
- Single Point Sampler
- PE, PTFE or 316L stainless steel product contact parts

Operation:

1. Cut the sampling tube to the required length or use the pre cut sterile tube.
2. Screw the collecting bottle to the base of the hand pump.
3. Insert one end of the sampling tube through the hand pump and into the collecting bottle.
4. Drop the other end of the sampling tube into the product. At the required depth pump the handle. Several pumps will fill the sample collecting bottle.

The pump is not a product contact part. Only the tube and collecting bottle come into contact with the product

Pump Efficiency

The plastic and stainless steel hand pumps are highly efficient and are able to pump water to a height of about 4m



Fast sampling of drums, kegs bins and containers

PTFE Pump Sampler Set

PTFE and PFA have excellent chemical resistance and are both food grade.

Set contains:

- 1 x plastic hand pump
- 1 x PTFE bottle adapter for PFA bottles
- 1 x PFA Bottle 180ml (5020A-04)
- 1 x Sampling Tube - PTFE - 5m length
- 1 x Tube cutter
- 1 x Stainless steel hose weight

Part No.	Description	Material
5020T-01	PTFE Pump Sampler Set	PTFE & PFA
Spares:		
Tubing	Spare Tubing see page 94	PE & PTFE
5020A-03	Sample bottle 90ml	PFA
5020A-04	Sample bottle 180ml	PFA
5020A-11	Adapter for pump and PFA sample bottles	PTFE
5020A-09	Plastic Hand Pump	Plastic
5020A-07	Tube Cutter	Plastic
5020A-08	Hose Weight	316L ss

5020T-01



POLYETHYLENE (PE) Pump Sampler Set

Set contains:

- 1 x Plastic Hand Pump
- 12 x PE Bottle 150ml (for set 5021P-150)
- 5 x PE Bottles 250ml (for set 5021P-250)
- 1 x PE Hose 13m
- 1 x Tube cutter
- 1 x Pen
- 1 x Carrying Case

Part No.	Description	Material
5021P-150	Pump Sampler Set with 12 x 150ml PE Bottles	PE
5021P-250	Pump Sampler Set with 5 x 250ml PE Bottles	PE

Spares		
Tubing	Spare Tubing see page 94	PE & PTFE
5021H-150	Sample Bottles 150ml HDPE	HDPE
5021H-250	Sample Bottles 250ml HDPE	HDPE
5020A-09	Plastic Hand Pump	Plastic
5020A-07	Tube Cutter	Plastic
5020A-08	Hose Weight	316L ss



5021P-150



5021P-250

STAINLESS STEEL Pump Sampler Set

Set contains:

- 1 x stainless steel hand pump and stainless steel bottle adapter
- 10 x PE Bottles 100ml (8130A-100)
- 1 x Sampling Tube - PE - 10m length
- 1 x Tube cutter
- 1 x Stainless steel hose weight
- 1 x Carrying case

Part No.	Description	Material
5020S-02	Stainless Steel Pump Sampler Set	316SS

Spares:		
Tubing	Spare Tubing see page 94	PE & PTFE
8130A-100	Sample bottle 100ml	PE body & PP lid
8130A-250	Sample bottle 250ml	PE body & PP lid
8130A-500	Sample bottle 500ml	PE body & PP lid
8130A-1000	Sample bottle 1000ml	PE body & PP lid
5020S-01	Stainless Steel Hand Pump	316L ss
5020A-07	Tube Cutter	Plastic
5020A-08	Hose Weight	316L ss



5020S-02

GLASS Pump Sampler Set

Set contains:

- 1 x Plastic Hand Pump
- 4 x Glass Bottle 500ml
- 1 x PE Hose 13m
- 1 x Tube cutter
- 1 x Pen
- 1 x Carrying Case

Part No.	Description	Material
5021G-500	Pump Sampler Set with 4 x 500ml Glass Bottles	Glass & PE

Spares		
Tubing	Spare Tubing see page 94	PE & PTFE
5021X-500	Sample bottle 500ml	Clear Glass
5020A-14	Plastic Hand Pump	Plastic
5020A-07	Tube Cutter	Plastic
5020A-08	Hose Weight	316L ss



5021G-500



Spare Tubing

Suitable for all Pump Samplers

All Pump Sampler sets include a length of 8mm diameter tubing. Tubing should be considered a consumable item.

PE Tubing

- Available in pre-cut lengths or a 100mm reel
- Made from food-grade LDPE which conforms to:
 - FDA 21 CFR 177.1520
 - EC 1935/2004
 - EU 10/2011
- External Diameter is 8mm, Internal Diameter is 6mm
- Available sterile

PTFE Tubing

- Available in lengths of 5m or a 100m reel
- Made from food-grade LDPE which conforms to:
 - FDA 21 CFR 177.1550
 - USP Class VI (5020T-100USP only)
- External Diameter is 8mm, Internal Diameter is 6mm



Part No.	Material	Length	Certification	Individually Bagged	Sterile	Quantity per Pack
5020L-01	PE	1m	Food Grade	Yes	No	100
5020L-01S	PE	1m	Food Grade	Yes	Yes	100
5020L-02	PE	2m	Food Grade	Yes	No	20
5020L-02S	PE	2m	Food Grade	Yes	Yes	20
5020L-04	PE	4m	Food Grade	Yes	No	15
5020L-04S	PE	4m	Food Grade	Yes	Yes	15
5020P-100	PE	100m	Food Grade	No	No	1
5020P-101	PE	100m	Food Grade	No	No	1
5020T-05	PTFE	5m	Food Grade	No	No	1
5020T-100	PTFE	100m	Food Grade	No	No	1
5020T-100USP	PTFE	100m	USP Class VI	No	No	1

PTFE Bottle Adapters

Use Your Existing Sample Collection Bottles

Custom Made to suit your bottle

If you wish to use your own sample bottles then PTFE adapters are available for a wide variety of standard bottle neck sizes. If your bottle has an unusual thread we can custom make you a special PTFE adapter.

When ordering a PTFE Bottle Adapter please send us one of your bottles so that we can match the thread pattern.

We keep bottle adapters for GL45 threads in stock.



Bottle with PTFE Bottle Adapter



Plastic Pump & PTFE Bottle Adapter

Part No.	To suit Pump Type	Description
5020X-45P	Plastic	PTFE Bottle Adapter for bottles with GL45 thread
5020X-1	Plastic	Custom made PTFE Bottle Adapter for bottle with a neck size less than 50mm
5020X-2	Plastic	Custom made PTFE Bottle Adapter for bottle with a neck size less than 100mm
5020X-3	Plastic	Custom made PTFE Bottle Adapter for bottle with a neck size greater than 100mm
5020X-45P-SS	Stainless Steel	PTFE Bottle Adapter for bottles with GL45 thread
5020X-1-SS	Stainless Steel	Custom made PTFE Bottle Adapter for bottle with a neck size less than 50mm
5020X-2-SS	Stainless Steel	Custom made PTFE Bottle Adapter for bottle with a neck size less than 100mm
5020X-3-SS	Stainless Steel	Custom made PTFE Bottle Adapter for bottle with a neck size greater than 100mm

PeriPump

High Speed Liquid Sampling up to 8m deep

Liquid sampling is fast and easy with the PeriPump Set. The set can be used to sample from almost everywhere including kegs, drums, vessels, wells, rivers and the sea. The PeriPump is suitable for low and medium viscosity liquids.

The powerful peristaltic pump is able take samples of water up to 8m deep. The PeriPump is therefore ideal for taking samples from a gantry or platform.

- Flow rate (with water at 2m) is approx 3L per minute
- Only the Tube and sample collection bottle are product contact parts
- The Battery Charger is supplied with a multi-pin adapter which allows it to be used in over 150 countries including Europe, USA, UK, Australia and China



Operation

1. Cut the Silicone Tube to the required length. Add the Tube Weight (if it is being used)
2. Pass the Tube through the Peristaltic Pump
3. Insert the end of the Tube with the weight into the liquid that is to be sampled
4. Insert the other end of the Tube into the sample collection container
5. Activate the Drive Unit - the pump will automatically self-prime and the sample will be pumped into the sample collection container

For contamination free sampling it is recommended that the Tube is changed after each use.



PeriPump Sampler Set 5224A-01 contains:

- 1 x Drive Unit with Peristaltic Pump
- 2 x Long life Li-ion Batteries
- 1 x Silicone Hose 10m (non-sterile)
- 1 x Tube Weight
- 1 x Battery Charger
- 1 x Multi-pin Adapter
- 1 x Carry Case



Liquid Samplers

Part No.	Description				
5224A-01	PeriPump Sampler Set				
SPARES					
Part No.	Description	Sterile	Length	Outer Diameter	Inner Diameter
5224S-5	Spare silicone tube. FDA, EC and BFR compliant grade	No	5m	11.1mm	6.3mm
5224S-10	Spare silicone tube. FDA, EC and BFR compliant grade.	No	10m	11.1mm	6.3mm
5224S-5S	Spare silicone tube. FDA, EC and BFR compliant grade	Yes	5m	11.1mm	6.3mm
5224S-10S	Spare silicone tube. FDA, EC and BFR compliant grade	Yes	10m	11.1mm	6.3mm

WARNING:
The PeriPump is not suitable for use with flammable solvents

NOTE:
Only use Silicone Tube type 5224S with the PeriPump. Other sizes of tube may not work

Liquid Dip Sampler

Surface Liquid Sampler

Volume 50ml to 100ml



The Liquid Dip Sampler is designed for taking samples from low viscosity liquids and suspensions. The device is designed so the sample can be quickly and easily emptied.

- Takes a sample at the surface of the liquid
- Made from 316L stainless steel

Operation

1. Insert the sampler into the product. The liquid will flow into the sampler.
2. Withdraw the sampler from the product
3. Press the Side Pins against the neck of the bottle to discharge the sample
4. After use the sampler can be quickly taken apart for cleaning

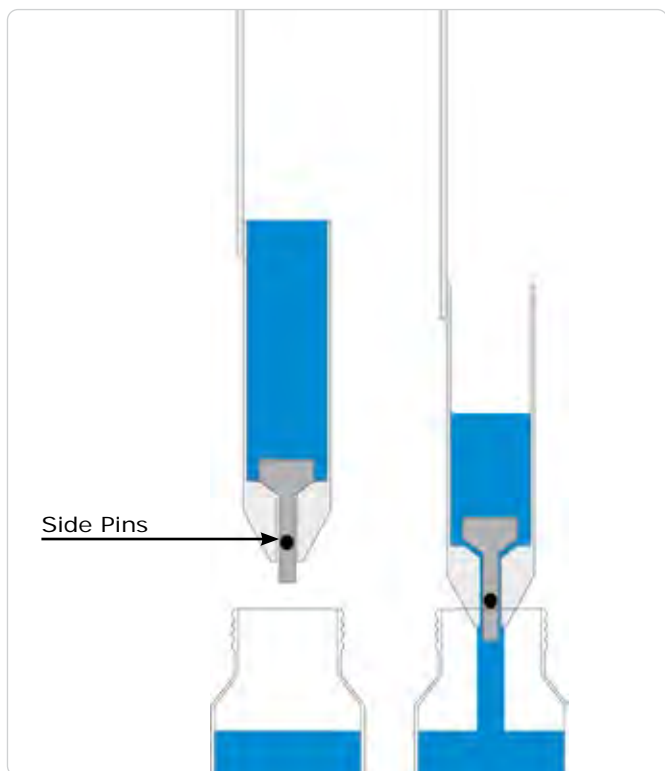
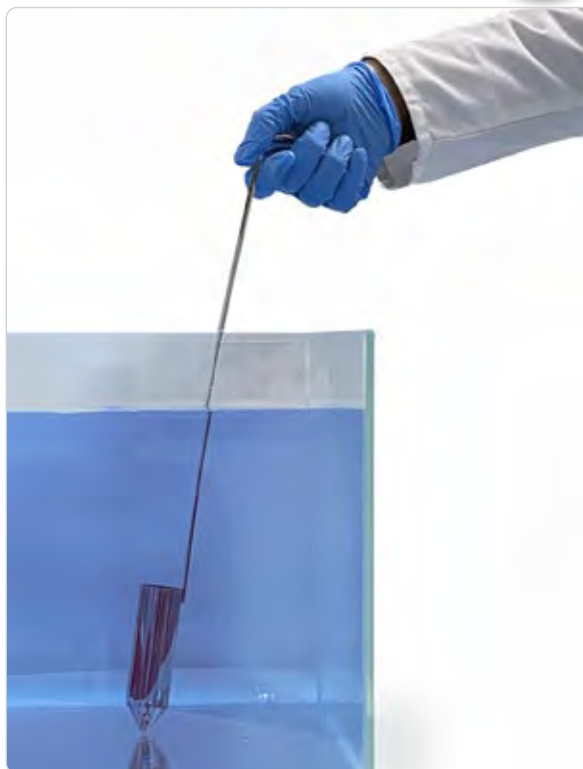

Press the Side Pins against the neck of the bottle to discharge the sample



Easy Hands free emptying

Part No.	Nominal Cup Volume	Overall Length	Max. Diameter of Cup	Material
5175A-50	50ml	470mm	32mm	316L ss
5175A-100	100ml	540mm	32mm	316L ss

Accessories	
Storage Cases	See page 176
XRF Certification	See page 118

Liquid Samplers

New sizes

Utility Dipper

Ideal for surface sampling

Volume 50ml to 250ml

An all stainless steel sampler suitable for sampling liquids and suspensions.

- Takes a sample at the surface of the liquid
- Made from 316L Stainless steel

Operation

1. Insert the sampler into the product. The liquid will flow into the sampler.
2. Withdraw the sampler from the product
3. Raise the centre control rod to discharge the sample

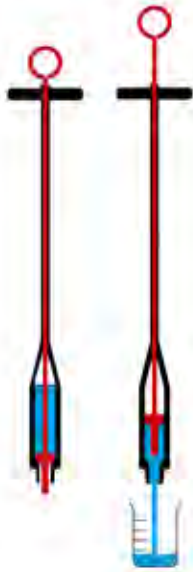

Raise the centre control rod (shown in red) to discharge the product

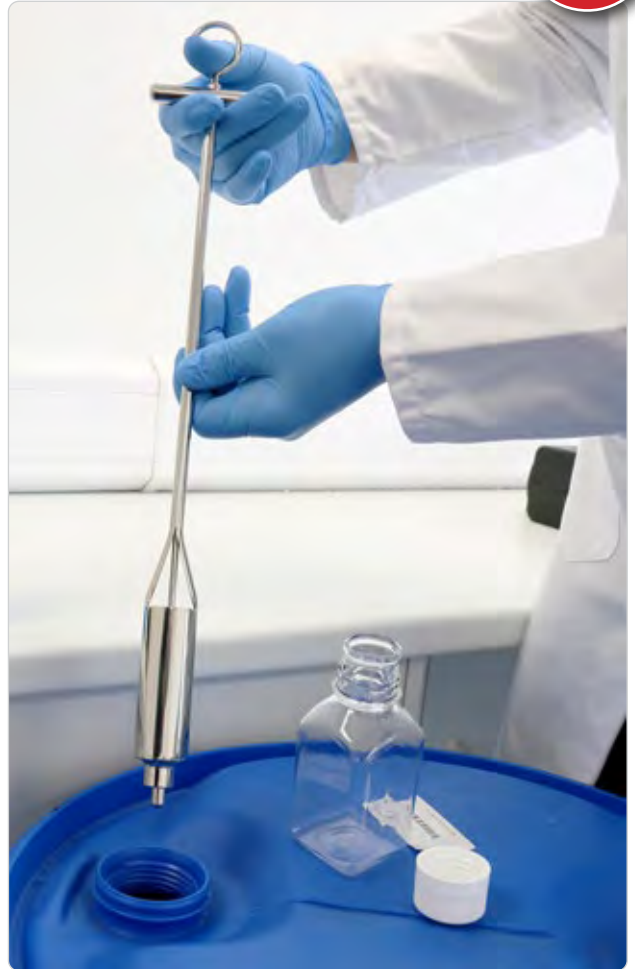

Part No.	Nominal Cup Volume	Overall Length	Max. Diameter of Cup	Material
5170A-50	50ml	490mm	32mm	316L ss
5170A-100	100ml	570mm	32mm	316L ss
5170A-250	250ml	570mm	51mm	316L ss

Accessories	
Storage Cases	See page 176
XRF Certification	See page 118

Liquid Samplers



Do you have a good idea?

Sampling systems are always happy to hear your ideas and suggestions.

However big or small your idea please contact us. The concepts for many of the samplers in our range originated from customer feedback, requests and ideas.

TeleScoop Pro

The Extendable Sampler For Liquid Sampling

Volume 250ml to 2000ml



The all new TeleScoop Pro is perfect for sampling liquids and suspensions.

The lightweight aluminium telescopic rods can be easily extended to the ideal length. A wide range of fittings can be quickly connected to ensure effortless sampling.

All Attachments are interchangeable with all Telescopic Rods. Our innovative Quick-Click Change System allows attachments to be changed in just a few seconds - no tools are required.

Ordering:

1. Choose your Telescopic Rod
2. Choose your attachments



1. Telescopic Rods

- Wide range of sizes
- New improved robust design
- Quickly extends to the required length in seconds
- Lightweight



Part No.	Description	Length	Number of Sections	Material
5065A-1001	Telescopic Rod 1000mm	1000mm	1	Aluminium & plastic
5065A-1201	Telescopic Rod 1200mm	750 to 1250mm	2	Aluminium & plastic
5065A-2501	Telescopic Rod 2500mm	1370 to 2500mm	2	Aluminium & plastic
5065A-2801	Telescopic Rod 2800mm	1050 to 2800mm	4	Aluminium & plastic
5065A-3001	Telescopic Rod 3000mm	1235 to 3000mm	3	Aluminium & plastic
5065A-4501	Telescopic Rod 4500mm	1720 to 4500mm	3	Aluminium & plastic
5065A-6001	Telescopic Rod 6000mm	1845 to 6000mm	4	Aluminium & plastic



**Quick-Click
Change
System**

No Tools Required

2. TeleScoop Pro Attachments



Angular Beaker 5065B

The beaker can be easily adjusted to the required angle



Wrist Strap 3111A

Ensures the sampler is not lost if it is accidentally dropped during use



Pendulum Beaker 5065C

Always swings to the upright position

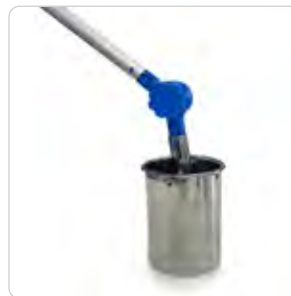

Stainless Pendulum Beaker 5065C

Sampling beaker made from 316L stainless steel. Always swings to the upright position



Bottle Holder 5065D

Suitable for bottles up to 95mm diameter. Price includes one 1000ml HDPE bottle & lid



Stainless Bottle Holder 5065D

Sampling bottle made from 316L stainless steel

Bottle supplied with lid and clamp

Part No.	Description	Nominal Volume	Material
5065B-252	Angular Beaker	250ml	PP
5065B-502	Angular Beaker	500ml	PP
5065B-1002	Angular Beaker	1000ml	PP
5065B-1001B	Angular Beaker	1000ml	316L Stainless Steel
5065B-2002	Angular Beaker	2000ml	PP
5065C-252	Pendulum Beaker	250ml	PP
5065C-502	Pendulum Beaker	500ml	PP
5065C-1002	Pendulum Beaker	1000ml	PP
5065C-1001B	Pendulum Beaker	1000ml	316L Stainless Steel
5065C-2002	Pendulum Beaker	2000ml	PP
5065D-502	Bottle Holder	500ml	HDPE/PP Bottle
5065D-503	Bottle Holder	500ml	316L Stainless Steel
5065D-1002	Bottle Holder	1000ml	HDPE/PP Bottle
SPARES			
5065G-1B	Elbow Fitting	n/a	PBT
8126H-500	Spare Bottle	500ml	HDPE body with PP lid. Box of 48
8126H-1000	Spare Bottle	1000ml	HDPE body with PP lid. Box of 24
A836-500	Spare Bottle	500ml	316L Stainless Steel
3111A-01	Wrist Strap	n/a	Nylon

Elbow Fitting 5065G-1B

The multi-angle Elbow Fitting allows the operator to achieve the perfect angle for sampling and is included with all of the attachments shown above (except the wrist strap).



Cup Sampler

Suitable for sampling liquids and suspensions

Volume 100ml to 500ml

The ever popular Cup Sampler is ideal for sampling liquids and suspensions. The device is manufactured from 316L stainless steel. The Cup Sampler enables discrete samples to be easily taken from specific heights within the product.

- Single Point Liquid Sampler
- 316L stainless steel product contact parts



Operation

1. Insert the sampler to the required depth.
2. Squeeze handle which pushes the cup away from the lid, allowing the liquid to enter the cup.
3. After filling remove the sampler. To empty the sampler either tip the sampler whilst squeezing the handle or unscrew the collecting cup.

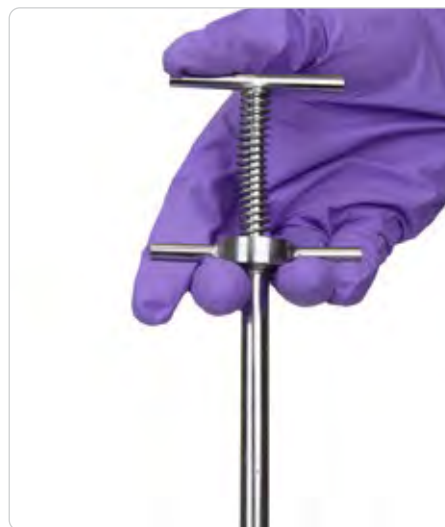
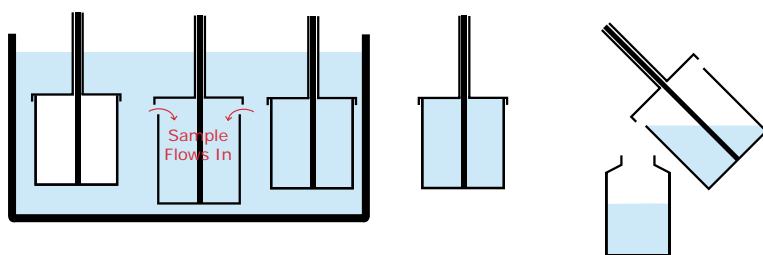

5030A-600

Part No.	Nominal Length	Nominal Cup Volume	Max. Diameter of Cup
5030A-600	600mm	100ml	55mm
5030A-1000	1000mm	100ml	55mm
5030A-1500	1500mm	100ml	55mm
5030J-1000	1000mm	500ml	80mm
5030J-1500	1500mm	500ml	80mm
Accessories			
Storage Cases	See page 176		
XRF Certification	See page 118		

Bottle Sampler

Takes Samples Straight into the bottle

Volume 60ml to 500ml

New

The Bottle Sampler takes samples straight into the bottle. The spring loaded mechanism means that liquid only flows in when the handle is squeezed allowing samples to be taken from set locations.

- Low to medium viscosity liquids.
- Single Point liquid sampling
- Sampler body - 316L stainless steel, Bottle - HDPE, Lid - PP

The Bottle Sampler is ideal for taking quick samples directly into the bottle.

After sampling the bottle can be unscrewed from the sampler.

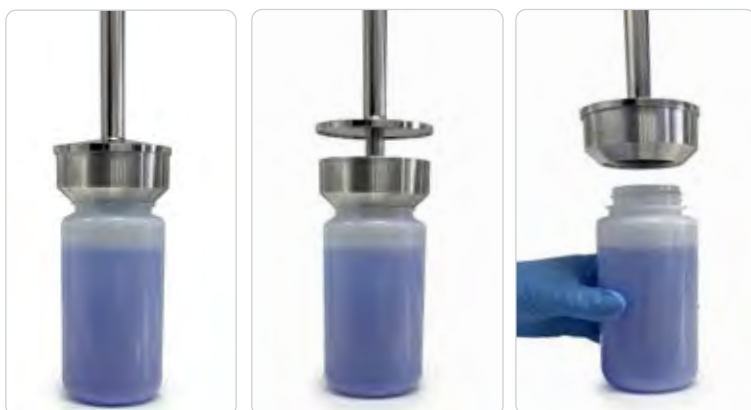

Liquid Samplers

Part No.	Overall Length including Bottle	Max. Diameter	Bottle Capacity	Supplied with
5033A-600	744mm	55mm	60ml	1 x 60ml bottle & lid
5033A-1000	1144mm	55mm	60ml	1 x 60ml bottle & lid
5033A-1500	1644mm	55mm	60ml	1 x 60ml bottle & lid
5033B-600	758mm	55mm	125ml	1 x 125ml bottle & lid
5033B-1000	1158mm	55mm	125ml	1 x 125ml bottle & lid
5033B-1500	1658mm	55mm	125ml	1 x 125ml bottle & lid
5033D-1000	1365mm	55mm	500ml	1 x 500ml bottle & lid
5033D-1500	1865mm	55mm	500ml	1 x 500ml bottle & lid

SPARES

Part No.	Bottle Type	Note
8126H-60	Wide Mouth Bottle 60ml - Box of 72	For use with 5033A
8126H-125	Wide Mouth Bottle 125ml - Box of 72	For use with 5033B
8126H-500	Wide Mouth Bottle 500ml - Box of 48	For use with 5033D
8404H-60S	Sterile Wide Mouth Bottle 60ml - Individually Bagged - Box of 50	For use with 5033A
8404H-125S	Sterile Wide Mouth Bottle 125ml - Individually Bagged - Box of 50	For use with 5033B
8404H-500S	Sterile Wide Mouth Bottle 500ml - Individually Bagged - Box of 30	For use with 5033D
XRF Certification	See page 118	

Fluid Point Sampler

Take liquid samples from a known point

Volume 160ml to 450ml



The Fluid Point Sampler is ideal for sampling pharmaceuticals, cosmetics and food stuffs. The design allows rapid point sampling from drums, kegs and most containers. The sampler works like a large syringe.

- Manufactured in 316L stainless steel with a silicone seal (FDA compliant grade)
- Available in different lengths
- Quickly taken apart for cleaning
- Available from stock for fast delivery worldwide

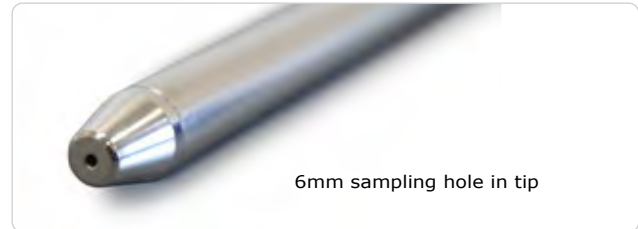

Operation

1. Insert the sampler into the liquid
2. Pull up the handle to take the sample
3. After sampling push down the handle to eject the sample.

Part No.	Nominal Length	Diameter	Max. Sample Volume	Material
5551S-600	600mm	25mm	160ml	316L ss & Silicone Seal
5551S-1000	1000mm	25mm	300ml	316L ss & Silicone Seal
5551S-1500	1500mm	25mm	450ml	316L ss & Silicone Seal
Accessories	Cleaning Brushes	See page 177		
	Storage Cases	See page 176		
	XRF Certification	See page 118		

Enviro Dipper Set

Environmental Surface Sampler

Volume 300ml

The Enviro Dipper Set contains everything you need to take surface samples. The set consists of a stainless steel bucket and a hand reel. The Hand Reel is pre-loaded with 50m of polypropylene string and a plastic hook.

The hand reel has a built in ratchet mechanism and brake.



Enviro Dipper Set comprises of:

- Bucket 300ml - 304 stainless steel
- Hand reel
- String (50m length, made from polypropylene)

Part No.	Description
5085A-01	Enviro Dipper Set (Hand reel, string and bucket)
Spares	
A725-300	Bucket 300ml - 304 stainless steel



Deep Water Sampler

Large volume environmental sampler

Volume 1000ml to 2500ml

The Deep Water Sampler is ideal for liquid and water sampling. It can be used in tanks, wells, containers, rivers and the sea.

The sampler has a flap valve at the top and bottom. As the sampler is lowered the water flows in through the bottom flap and out through the top. When the sampling depth is reached the flap valves automatically close. As the sampler is raised the pressure of the water will keep the top flap closed, this will prevent any new water from entering the sampler.

To discharge the liquid simply open the valve on the side.

- Graduated
- Supplied with 15m rope
- Transparent so its easy to visually inspect what has been sampled
- Made from robust plexiglass
- Ideal for chemical and environmental sampling
- Stratified sampling is quick and easy



Part No.	Nominal Volume	Diameter	Height	Material
5079A-1000	1000ml	100mm	300mm	Plastic & Plexiglass
5079A-2500	2500ml	130mm	340mm	Plastic & Plexiglass

In Stream Sampler

Surface sampler for flowing liquids

Volume 500ml



The In Stream Sampler is a useful piece of equipment for taking samples from a product that is flowing. Alternatively it can be used to take samples directly from the surface of containers or vessels.

The In Stream Sampler is made from robust 316L stainless steel. It can be used for sampling both powders and liquids.

- Multi purpose sampler
- 316L stainless steel
- Crevice free interior
- Fully welded construction
- Available from stock
- Polished finish



Part No.	Nominal Volume	Max. Diameter of Cup	Handle Length
A996-500	500ml	95mm	1000mm
Accessories	Storage Cases	See page 176	
	XRF Certification	See page 118	

Liquid Samplers

Stainless Dipper

GMP Correct Liquid Sampler

- 316L stainless steel construction
- Fully welded
- Satin finish



Part No.	Nominal Volume	Overall Length	Outside Cup Diameter
5005A-50	50ml	600mm	32mm
5005A-100	100ml	600mm	39mm
5005A-250	250ml	600mm	63mm
5005A-500	500ml	600mm	76mm
5005B-50	50ml	1000mm	32mm
5005B-100	100ml	1000mm	39mm
5005B-250	250ml	1000mm	63mm
5005B-500	500ml	1000mm	76mm
5005C-50	50ml	1500mm	32mm
5005C-100	100ml	1500mm	39mm
5005C-250	250ml	1500mm	63mm
5005C-500	500ml	1500mm	76mm

Volume 50ml to 500ml

New sizes



PTFE Dipper

Excellent Chemical Resistance - GMP correct

- PTFE product contact parts
- Screw-in extension rods to increase the length of the handle

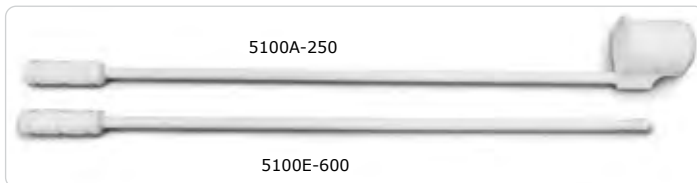

Part No.	Nominal Volume	Cup Diameter	Handle
5100A-100	100ml	55mm	600mm long - removable
5100A-250	250ml	70mm	600mm long - removable
5100A-500	500ml	80mm	600mm long - removable
5100A-1000	1000ml	105mm	600mm long - removable
5100E-600	Handle Extension rod - 600mm long		
5100E-1000	Handle Extension rod - 1000mm long		

Volume 100ml to 1000ml

New sizes



PTFE Mini Dipper

Excellent Chemical Resistance - GMP correct

Volume 10ml

Ideal for surface sampling small volumes of liquids

- PTFE construction
- Chemically resistant



Part No.	Nominal Volume	Cup Diameter	Handle
5100A-10	10ml	25mm	150mm long - fixed in place

SteriWare® Ladle

Efficient surface sampling of liquids

Volume 50ml to 100ml

The SteriWare® Ladle is ideal for the surface sampling of liquids. They can be used straight-from-the-bag; simply unwrap and use.

The one piece design has been specially constructed to go through standard 2" lid bungs which are commonly found on barrels and kegs.

- Manufactured and packed in a Cleanroom
- Individually Bagged
- Made from FDA, EC 1935/2004 & EU 10/2011 conforming materials
- BSE/TSE Free
- Full Batch Traceability
- Available Sterile (gamma irradiated)



Part No.	Nominal Volume	Diameter	Colour	Sterile	Material of Construction	Box Quantity
8053H-50	50ml	48mm	Natural	No	HDPE	40
8053H-50S	50ml	48mm	Natural	Yes	HDPE	40
8053P-100	100ml	43mm	Natural	No	PP	40
8053P-100S	100ml	43mm	Natural	Yes	PP	40
8053B-50	50ml	48mm	Blue	No	PP	40
8053B-50S	50ml	48mm	Blue	Yes	PP	40

Stainless Ladle

Efficient surface sampling of liquids

Volume 50ml to 200ml

- Satin finish
- 204 or 316L stainless steel
- All stainless steel construction
- Crevice free construction



Part No.	Nominal Volume	Bowl Diameter	Handle Length	Material
A326-150	150ml	88mm	370mm	316L ss
A324-50	50ml	62mm	215mm	204 ss
A324-120	120ml	82mm	270mm	204 ss
A324-150	150ml	92mm	270mm	204 ss
A324-200	200ml	101mm	270mm	204 ss

Immersion Cylinder Sampler

Immersion Cylinders are designed to take liquid samples

Volume 300ml to 1000ml

New

Immersion Cylinders are designed to take liquid samples from open water, wells, tanks, drums and large storage containers. They are made from 304 stainless steel or brass and are available in a range of sizes.

The Immersion Cylinder is designed to be easy to clean. Both ends of the sampler unscrew for easy cleaning.

Immersion Cylinders are designed for environmental and general industrial sampling. For GMP applications we recommend the 5072B-500 sampler on page 107.

Two Methods of Sampling

1. When the sampler reaches the bottom of the tank the sampler automatically opens.
2. When the sampler is mid-level, a second control line is used to open the sampler

Note: Hand reels and cables are sold separately. See page 124



Part No.	Volume	Diameter	Height	Material
5132S-300	300ml	70mm	129mm	304 ss
5132S-500	500ml	70mm	168mm	304 ss
5132S-1000	1000ml	70mm	303mm	304 ss
5132B-300	300ml	70mm	125mm	Brass
5132B-500	500ml	70mm	183mm	Brass
5132B-1000	1000ml	70mm	300mm	Brass

Dipping Bottle

Take samples from open water as well tanks, drums, wells

Volume 300ml to 1000ml

New

Dipping Bottles are designed to take samples from open water as well tanks, drums, wells and large storage containers. They are made from either 304 stainless steel or brass and are available in a range of sizes.

The operator lowers the Dipping Bottle until the sampling depth is reached. The operator then pulls sharply upwards and this pulls the aluminium stopper out of the bottle, this allows the liquid to flow in.

Dipping Bottles are designed for environmental and general industrial sampling. For GMP applications we recommend the 5072B-500 sampler on page 107.

- Bottles - made from 304 stainless steel or brass
- Lids - made from aluminium

Note: Hand reels and cables are sold separately. See page 124



Part No.	Volume	Diameter	Height	Material
5332S-300	300ml	75mm	153mm	304 ss & Aluminium
5332S-500	500ml	75mm	207mm	304 ss & Aluminium
5332S-1000	1000ml	75mm	325mm	304 ss & Aluminium
5332B-300	300ml	62mm	162mm	Brass & Aluminium
5332B-500	500ml	62mm	240mm	Brass & Aluminium
5332B-1000	1000ml	77mm	300mm	Brass & Aluminium

Sub Sampler Pro

The Best Selling Heavy Duty Liquid Sampler

Volume 500ml to 1000ml

The Sub Sampler Pro (some times called a 'Bomb Sampler') is used throughout the world for both chemical and environmental sampling. Its unique double action means it can sample from a set distance from the bottom of a container or alternatively at a mid point in a container or well for example.

A. Sample from the bottom of a container

- Use a **Lowering Cable**

The Sub Sampler Pro is lowered until the plunger assembly touches the bottom of the container. As the plunger assembly is pushed up the sample is able to enter the device. When the sampler is raised the plunger will drop down and seal the sampler.

Liquid flows in when the sampler hits the bottom

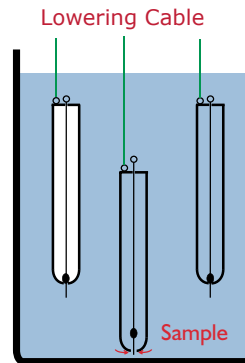

B. Mid-height Sampling

- Use a **Lowering Cable** and a **Control Line**

Lower the Sub Sampler Pro into the liquid. At the required sampling depth pull on the control line to raise the plunger. This will allow the liquid to enter the sampler. Release the control line and the plunger will drop down and seal the sampler.

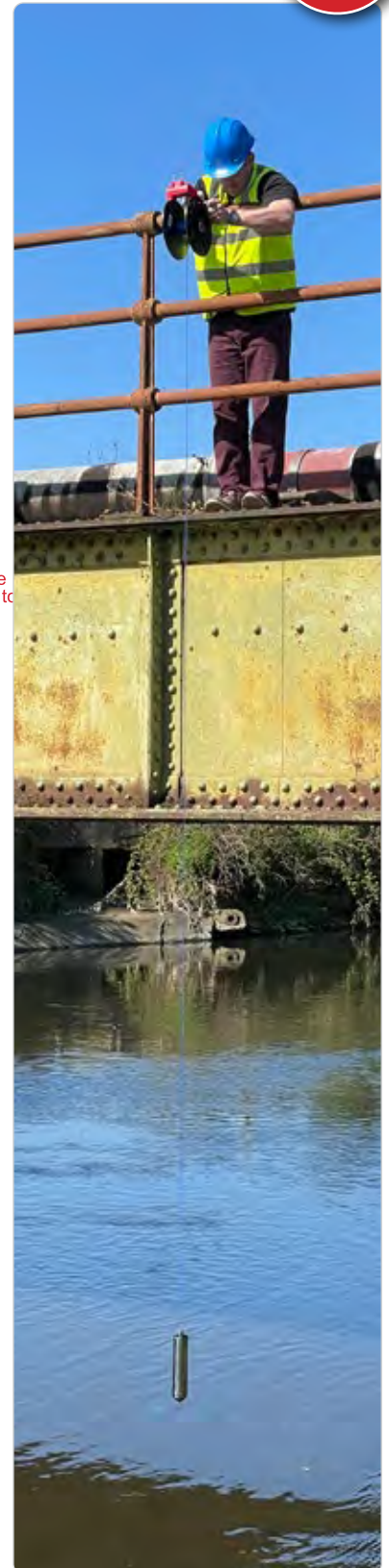
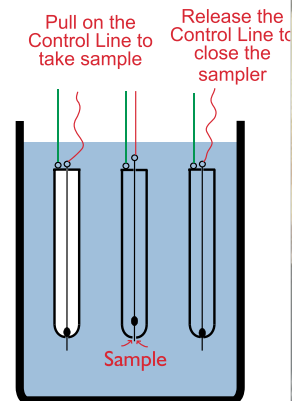

Liquid Samplers



- (A) 5072A-500
- (B) 5072A-1000
- (C) 5072B-500
- (D) 5072P-500

Part No.	Nominal Volume	Material	Diameter x Length	Ex Rated
5072A-500	500ml	Nickel plated brass	52 x 427mm	No
5072A-1000	1000ml	Nickel plated brass	75 x 438mm	Yes*
5072B-500	500ml	316L Stainless steel	66 x 300mm	No
5072P-500	500ml	PTFE	70 x 371mm	No

* Make sure the sampler is properly earthed (grounded) use the Ex Hand Reel (5070D-05) and Copper cable (5070C)
 Don't forget to order your Hand Reel and Cable - see page 124

SteriWare® LiquiDip

The Self Closing Liquid Sampler

Volume 80ml to 225ml

The new disposable LiquiDip sampler from Sampling Systems is ideal for taking cross sectional samples of liquids. The special valve at the end of the sampler automatically closes when pushed against the bottom of the container.

- Individually bagged
- FDA and EC conforming material
- Cleanroom assembly and packing (ensures cleanliness)
- Available both sterile and non-sterile
- Available from stock for fast delivery worldwide

See Page 44 for full details



Part No.	Length	Nominal Capacity	Sterile	Material	Box Quantity
8921H-450	450mm	80ml	No	HDPE	20
8921H-450S	450mm	80ml	Yes	HDPE	20
8921H-1100	1100mm	225ml	No	HDPE	20
8921H-1100S	1100mm	225ml	Yes	HDPE	20

Disposable Bailer

Popular For Environmental Sampling

Volume 900ml

The sampler can either be manually pushed into the liquid or it can be lowered on the end of a cable. The Disposable Bailer is ideal for sampling from streams, tanks or wells.

For viscous materials use the bailer fitted with an end weight (Part No. 5040W-1000)

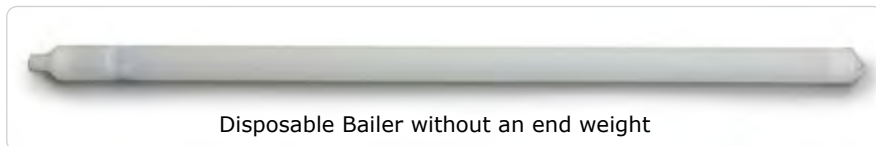

The plastic ball in the end of the sampler is pushed out of the way when the sampler is lowered into the product.

When the sampler is raised the plastic ball seals the sampler.

Note: This sampler is not suitable for high density liquids

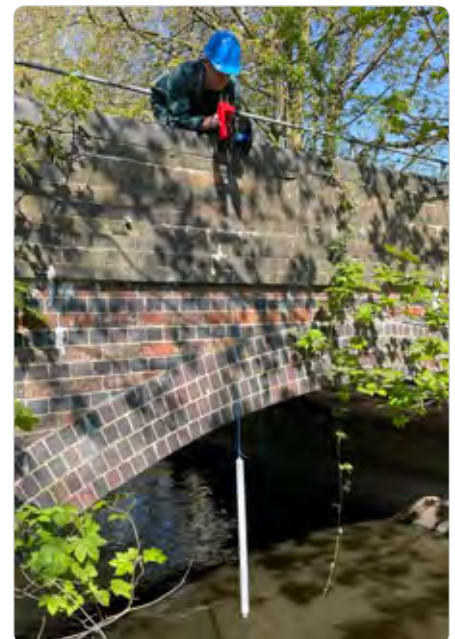
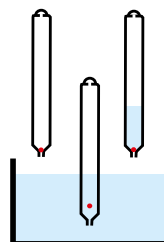

Part No.	Nominal Volume	Weighted End	Individually Bagged	Material	Length	Diameter	Quantity Per Box
5040A-1000	900ml	No	Yes	HDPE	950mm	40mm	24
5040W-1000	900ml	Yes	Yes	HDPE	950mm	40mm	24

Cables & Handle Reel see page 124

SteriWare® LiquiThief

Single Use Disposable Liquid Sampler

Volume 100ml to 300ml

- Ideal for sampling low viscosity liquids and oils
- Fully welded construction (no adhesives or screws are used)
- Assembled in a medical clean room
- Each sampler is individually wrapped
- Made from FDA acceptable polymers
- Simply pull the handle to take a sample

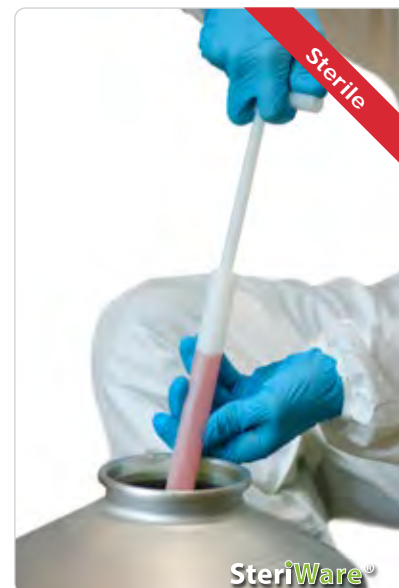

Part No.	Sampler Length	Sterile	Max. Sample Volume	Material	Outer Diameter	Box Quantity
8050H-500	500mm	No	100ml	HDPE	21mm	20
8050H-500S	500mm	Yes	100ml	HDPE	21mm	20
8050H-1000	1000mm	No	190ml	HDPE	21mm	20
8050H-1000S	1000mm	Yes	190ml	HDPE	21mm	20
8050H-1500	1500mm	No	300ml	HDPE	21mm	20
8050H-1500S	1500mm	Yes	300ml	HDPE	21mm	20

SteriWare® Jumbo Pipettes

Low Cost Disposable Liquid Samplers

Volume 80ml to 225ml

The Jumbo Pipette is both quick and easy to use. It is ideal for taking samples from low viscosity liquids. The Jumbo Pipette is part of our SteriWare® range.

- Quick and easy to use
- Available in three lengths
- Individually wrapped
- Assembled in a Cleanroom
- Available pre-sterilised
- Made from HDPE (FDA acceptable grade conforms to CFR 177.1520)
- Colour-coded blue end to avoid handling errors

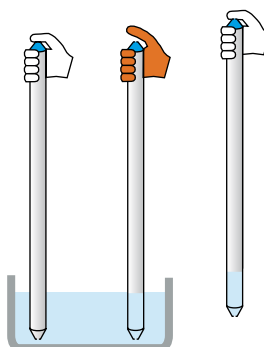

Part No.	Overall Length	Overall Diameter	Internal Diameter	Sterile	Max. Sample Volume	Material	Box Quantity
8051H-450	450mm	21mm	17mm	No	80ml	HDPE	50
8051H-450S	450mm	21mm	17mm	Yes	80ml	HDPE	50
8051H-900	900mm	21mm	17mm	No	180ml	HDPE	50
8051H-900S	900mm	21mm	17mm	Yes	180ml	HDPE	50
8051H-1100	1100mm	21mm	17mm	No	225ml	HDPE	50
8051H-1100S	1100mm	21mm	17mm	Yes	225ml	HDPE	50

Multi Dipper 2

Multilevel Liquid Sampler

Volume 250ml per bottle

The Multi Dipper 2 is the ideal solution for taking liquid samples from different levels. The sample collection bottles remain closed until the operator uses the control chain to remove the stoppers.

High security stainless steel shackles are used to secure the plugs to the control chain

Product contact parts are:

- Sampler frame 316L stainless steel
- Control Chain 316 stainless steel
- Plugs 316L stainless steel
- Plug Shackles 316 stainless steel
- Sample Bottle HDPE

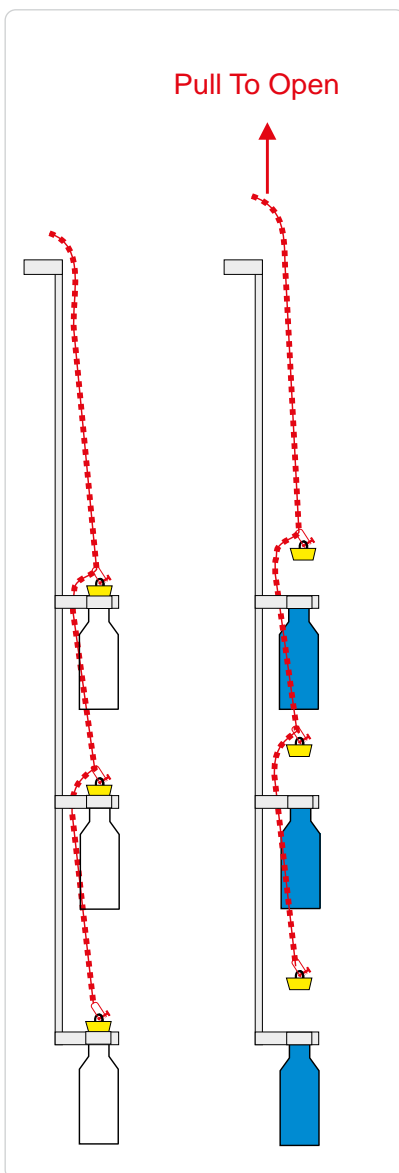

Operation

1. Attach the bottle into the holders
2. Insert the plugs into the tops of the sample bottles
3. Connect the Control Chain to the plugs
4. Insert the assembled sampler into the liquid to be sampled
5. Pull on the Control Chain to open the bottles
6. Remove sampler from the liquid tank

Part No.	Overall Length	Sample Bottles
5045A-1000	1000mm	3 x 250ml included (8165A-250)
5045A-1500	1500mm	3 x 250ml included (8165A-250)
5045A-2000	2000mm	3 x 250ml included (8165A-250)
8165A-250	Spare Sample Bottles 250ml HDPE	

Special sizes and designs are available on request

Cream, Ice and Wax Samplers



Mini-Corer

- Suitable for sampling wax, cheese, greases, powders, granules
- Made from 316L stainless steel
- High quality bright polish finish
- Crevice free construction

Operation:

1. Rotate the handle as the sampler is pushed into the product. A core of the product will be cut.
2. Remove sampler.



Part No.	Sampler Length	Maximum Sampler Diameter	Stainless Steel
7008A-01	190mm	18mm	316L ss
7008A-02	235mm	18mm	316L ss
7008A-03	295mm	18mm	316L ss
8505A-12	Storage Case		

Corer

- Suitable for sampling wax, cheese, greases, powders, granules
- Made from 316L stainless steel
- High quality bright polish finish
- Crevice free construction

Operation:

1. Push the Outer tube into the product.
2. Use the Push Rod to eject the core of product from the Outer Tube

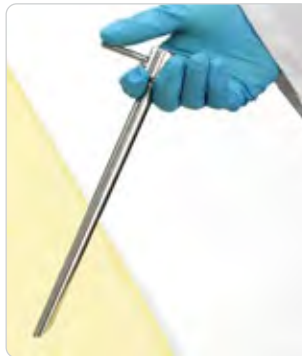

Part No.	Sampler Length	Maximum Sampler Diameter	Stainless Steel
7009A-01	230mm	12mm	316L ss
8505A-12	Storage Case		

Maxi-Corer

- 316L stainless steel construction
- Two sizes
- Crevice free
- Satin finish



Part No.	Diameter	Overall Length	Blade Length	Stainless Steel
7010A-01	25mm	300mm	200mm	316L ss
7010A-02	25mm	600mm	500mm	316L ss

Sample Lance

Durable Multi-purpose Sampler

The Sample Lance is ideal for taking cross sectional samples of pastes and soft waxy materials. It is manufactured from high quality 316L stainless steel.

The Sample Lance is available with two of different handles. The Heavy Duty Handles makes it easier to sample powders that are hard and dense, since they give additional leverage when the sampler is pushed into the product.

For sampling powders that are light and fluffy we recommend a Plain Sample Lance as these do not have handles. Heavy Duty handles are suitable for all other applications.

Operation: Just push the sampler into the powder to take a core sample.

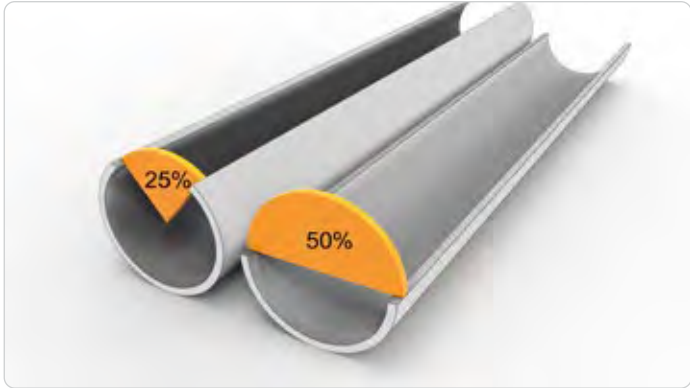

- Manufactured in 316L stainless steel
- Available in different sizes and handle combinations
- Can be used in the laboratory or on site
- Available from stock

Part No.	Length	Lance Opening Size	Handle Type	Width	Material
1660P-600	600mm	25%	Plain	25mm	316L ss
1660P-1000	1000mm	25%	Plain	25mm	316L ss
1665P-400	400mm	50%	Plain	25mm	316L ss
1665P-600	600mm	50%	Plain	25mm	316L ss
1665P-1000	1000mm	50%	Plain	25mm	316L ss
1660H-600	600mm	25%	Heavy Duty	25mm	316L ss
1660H-1000	1000mm	25%	Heavy Duty	25mm	316L ss
1665H-600	600mm	50%	Heavy Duty	25mm	316L ss
1665H-1000	1000mm	50%	Heavy Duty	25mm	316L ss
Accessories	Storage Cases	See page 176			
	XRF Certification	See page 118			

Viscous Sampler

Reusable Sampler for creams, pastes & gels

Volume 160ml to 650ml

Ideal for sampling creams, shampoos, soaps, honey and other semi viscous materials. After sampling the sampler can be completely dismantled into its component parts for quick and thorough cleaning.

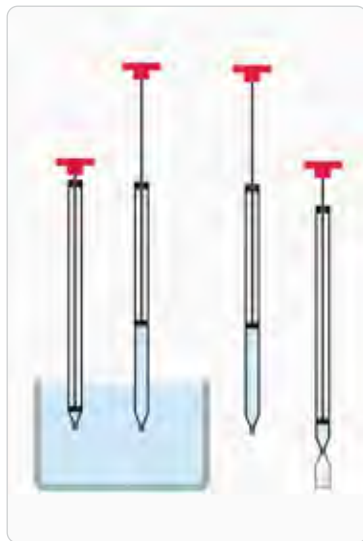

Operation:

1. Insert the sampler into the product
2. At the required depth pull handle to draw product into the sampler
3. Remove the sampler from the product. Run the cleaning ring down the sampler to remove any product that adheres to the side of the sampler
4. Push down the handle to push out the sample



7000S-1000



7000T-1000



7000P-600

Part No.	Overall Length	Material of Construction	Max. Sample Volume	Diameter of Hole in Tip
7000S-600	600mm	316L stainless steel	160ml	10mm
7000S-1000	1000mm	316L stainless steel	300ml	10mm
7000S-1500	1500mm	316L stainless steel	450ml	10mm
7000P-600	600mm	PP	160ml	10mm
7000P-1000	1000mm	PP	300ml	10mm
7000P-2000	2000mm	PP	650ml	10mm
7000T-600	600mm	PTFE	160ml	10mm
7000T-1000	1000mm	PTFE	300ml	10mm
7000T-2000	2000mm	PTFE	650ml	10mm

Accessories

Cleaning Brushes	See page 177
Storage Cases	See page 176
XRF Certification	See page 118

See page 49 for a single use, disposable version of the Viscous Sampler

Note: For low viscosity liquids (e.g. water) use the Liquid Master - see pages 90-91

SteriWare® ViscoThief

Single use Cream & Oil Sampler

Volume 100ml to 290ml

Avoid time consuming cleaning with our disposable range of ViscoThief samplers. The Disposable ViscoThief is a single use sampler that is designed for use with viscous materials.

- Suitable for creams, pastes and gels
- 10mm diameter sampling hole in the tip
- Fully welded construction (no adhesives or screws are used)
- Assembled in a medical clean room
- Each sampler is individually wrapped
- Made from HDPE (FDA acceptable grade conforms to CFR 177.1520)
- FDA acceptable silicone rubber is used for the piston seal - FDA 21 CFR 177.2600

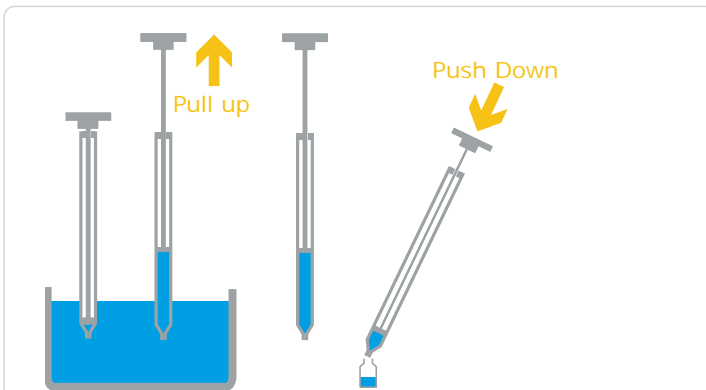

Operation:

1. Insert the sampler into the product
2. At the required depth pull up the handle. The sample will be drawn into the sampler
3. Withdraw sampler
4. Push down handle to expel the sample



Semi-Solid Samplers



Part No.	Sampler Length	Sterile	Diameter of Hole in Tip	Max. Sample Volume	Material	Outer Diameter	Box Quantity
8055H-500	500mm	No	10mm	100ml	HDPE	21mm	20
8055H-500S	500mm	Yes	10mm	100ml	HDPE	21mm	20
8055H-1000	1000mm	No	10mm	190ml	HDPE	21mm	20
8055H-1000S	1000mm	Yes	10mm	190ml	HDPE	21mm	20
8055H-1500	1500mm	No	10mm	290ml	HDPE	21mm	20
8055H-1500S	1500mm	Yes	10mm	290ml	HDPE	21mm	20

Ice Sampler

Best Selling Ice Sampler

Volume 50ml

The ice sampler was specially designed for sampling icy and waxy materials. The sample cover can be easily removed to give access to the sample.

- Suitable for sampling ice, wax and other similar materials
- Single point sampler
- Made from 316L stainless steel
- The sample cover can be quickly removed to allow quick emptying

Operation:

1. Rotate the handle as the sampler is pushed into the product. The scroll will cut into the product and the sample will be deposited in the sample collecting chamber.
2. Removing the cylinder allows the sample to be accessed.



Part No.	Length	Sample Volume	Diameter of Sampling Head	Stainless Steel
6000A-300	300mm	50ml	40mm	316L
6000A-550	550mm	50ml	40mm	316L
6000A-1050	1050mm	50ml	40mm	316L
Storage Cases	See page 176			
XRF Certification	See page 118			

Ice Cream Sampler

Hygienic, stainless steel Sampler

Volume 30ml

The Ice Cream Sampler is ideal for sampling products like ice cream and soft waxes.

The Ice Cream Sampler has an all stainless steel construction and is designed to be easily dismantled for cleaning. The sampler is supplied with a clear plastic test tube.



Part No.	Diameter	Max. Sample Volume	Material of Construction
6006A-100	25mm	30ml	316L stainless steel with clear polystyrene test tube
6006A-101	Test Tube made from clear polystyrene (PS)		
8020J-600	Cleaning Brush		



Powered Ice Sampler

Efficient Large Volume Sampler

Volume 4ml to 400ml



The Powered Ice Sampler is designed to be used with virtually any electric drill.

Manufactured from chemically resistant 316L stainless steel.

- Fits all standard electric drills (Note: drill not supplied)
- Takes samples in seconds
- Different diameters available allowing you to take everything from a very small samples right up to 400ml.
- Available from stock
- Ejection rods available for the 20 and 50mm sizes.
- Easy clean design



- Notes:
1. The electric drill is not included
 2. Discharge Rods are sold separately

Part No.	Description	Max. Sample Volume	Length	Material
6011A-10	Powered Ice Sampler. 10mm diameter	4ml	130mm	316L ss
6011A-20	Powered Ice Sampler. 20mm diameter	40ml	255mm	316L ss
6011A-20D	Discharge rod for 20mm powered ice sampler	n/a	255mm	316L ss
6010A-50	Powered Ice Sampler Body. 50mm diameter	400ml	320mm	316L ss
6010A-50D	Discharge rod for 50mm powered ice sampler	n/a	320mm	316L ss

Semi-Solid Samplers

Meat & Cheese Sampler

Surface Sampler

The Meat & Cheese Sampler is designed to take a sample to a depth of 10mm from the surface. The sampler has a sharp edge to help cut into the product.

- Made from 316L stainless steel
- Bright polish
- Sample size: 25mm diameter x 10mm deep

Part No.	Overall Length	Material
6015A-150	180mm	316L ss



Ice Borer

Robust, efficient Ice Sampler

- Suitable for ice, wax and other similar materials
- Made from 316L stainless steel

Operation:

1. Rotate the handle as the sampler is pushed into the product. The sharp edge will cut into the product and the sample core will be deposited in the tube.
2. Push the Discharge Rod down the Ice Borer to remove the sample.



Part No.	Description	Length	Outer Diameter	Material
6005A-500	Ice Borer	500mm	25mm	316L ss
6005A-1000	Ice Borer	1000mm	25mm	316L ss
8570A-700	Sample Discharge Rod	700mm	18mm	316L ss
8570A-1100	Sample Discharge Rod	1100mm	18mm	316L ss
Cleaning Brushes	See page 177			
Storage Case	See page 176			
XRF Certification	See page 118			

Material Certification

Positive Material Identification of 304 & 316 stainless steel

XRF Certification

XRF Certification is available (as an extra cost option) for all stainless steel products.

What is XRF?

Our hand-held XRF Spectrometers enable us to quickly identify the exact grade of stainless steel that has been used for each part of a product.

Stainless steel is an alloy containing a number of different elements. XRF Spectrometers can accurately identify the elements and their concentrations in the item being tested.

XRF is non-marking and so is ideal for use on finished products.

Your certificate will state the grade of stainless steel used for your products.



Environmental Sampling



TeleScoop

The Extendable Sampler For Liquid Sampling

Volume 250ml to 2000ml



The all new TeleScoop Pro is perfect for sampling liquids and suspensions.

The lightweight aluminium telescopic rods can be easily extended to the ideal length. A wide range of fittings can be quickly connected to ensure effortless sampling.

All Attachments are interchangeable with all Telescopic Rods. Our innovative Quick-Click Change System allows attachments to be changed in just a few seconds - no tools are required.

Ordering:

1. Choose your Telescopic Rod
2. Choose your attachments



1. Telescopic Rods

- Wide range of sizes
- New improved robust design
- Quickly extends to the required length in seconds
- Lightweight



Part No.	Description	Length	Number of Sections	Material
5065A-1001	Telescopic Rod 1000mm	1000mm	1	Aluminium & plastic
5065A-1201	Telescopic Rod 1200mm	750 to 1250mm	2	Aluminium & plastic
5065A-2501	Telescopic Rod 2500mm	1370 to 2500mm	2	Aluminium & plastic
5065A-2801	Telescopic Rod 2800mm	1050 to 2800mm	4	Aluminium & plastic
5065A-3001	Telescopic Rod 3000mm	1235 to 3000mm	3	Aluminium & plastic
5065A-4501	Telescopic Rod 4500mm	1720 to 4500mm	3	Aluminium & plastic
5065A-6001	Telescopic Rod 6000mm	1845 to 6000mm	4	Aluminium & plastic



**Quick-Click
Change
System**

No Tools Required

2. TeleScoop Pro Attachments



Angular Beaker 5065B

The beaker can be easily adjusted to the required angle



Wrist Strap 3111A

Ensures the sampler is not lost if it is accidentally dropped during use



Pendulum Beaker 5065C

Always swings to the upright position

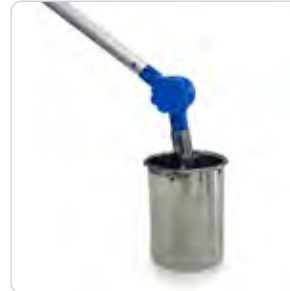

Stainless Pendulum Beaker 5065C

Sampling beaker made from 316L stainless steel



Bottle Holder 5065D

Suitable for bottles up to 95mm diameter. Price includes one 1000ml LDPE bottle & lid



Stainless Bottle Holder 5065D

Sampling bottle made from 316L stainless steel

Bottle supplied with lid and clamp

Part No.	Description	Nominal Volume	Material
5065B-252	Angular Beaker	250ml	PP
5065B-502	Angular Beaker	500ml	PP
5065B-1002	Angular Beaker	1000ml	PP
5065B-1001B	Angular Beaker	1000ml	316L Stainless Steel
5065B-2002	Angular Beaker	2000ml	PP
5065C-252	Pendulum Beaker	250ml	PP
5065C-502	Pendulum Beaker	500ml	PP
5065C-1002	Pendulum Beaker	1000ml	PP
5065C-1001B	Pendulum Beaker	1000ml	316L Stainless Steel
5065C-2002	Pendulum Beaker	2000ml	PP
5065D-502	Bottle Holder	500ml	HDPE/PP Bottle
5065D-503	Bottle Holder	500ml	316L Stainless Steel
5065D-1002	Bottle Holder	1000ml	HDPE/PP Bottle
SPARES			
5065G-1B	Elbow Fitting	n/a	PBT
8126H-500	Spare Bottle	500ml	HDPE body with PP lid. Box of 48
8126H-1000	Spare Bottle	1000ml	HDPE body with PP lid. Box of 24
A836-500	Spare Bottle	500ml	316L Stainless Steel
3111A-01	Wrist Strap	n/a	Nylon

Remember to buy the telescopic rods with your attachments

Elbow Fitting 5065G-1B

The multi-angle Elbow Fitting allows the operator to achieve the perfect angle for sampling and is included with all of the attachments shown above (except the wrist strap).



Snapper

Snaps Shut to Capture Sediment & Sludge

Volume 250ml

The Snapper has been specially designed to take samples of sediment and sludge in rivers, wells, tanks etc.

- Easy to use
- Holds approximately 250ml
- Spring loaded mechanism automatically snaps shut on contact with the sediment
- Use with the telescopic pole that extends up to 4.5m

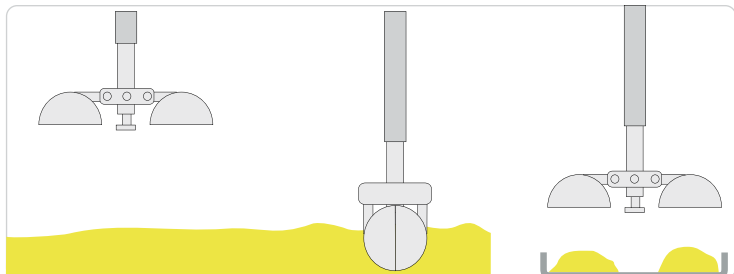

Part No.	Description
5061A-250	Snapper - 250ml sample volume
5061T-4500	Telescopic rod. Extends up to 4.5m

Note: Snapper & Telescopic rods are sold separately

Environmental

Catch Nets

Take samples from rivers, streams and ponds

Catch Net enable floating and suspended debris to be quickly and easily caught.

The Surface Net has a flat profile and the Deep Catch Net has a deep pocket

Catch Nets are designed to attach directly onto the Telescopic Rod.



Part No.	Description	Nominal Dimensions	Mesh Size
5065M-310	Surface Catch Net	310 x 280mm	2 to 5mm
5065N-190	Deep Catch Net	190 x 430mm	2 to 5mm
5061T-4500	Telescopic Rod	Extends from 1720mm to 4500mm	N/A

Note: Catch Nets & Telescopic rods are sold separately



Enviro Dipper Set

Environmental Surface Sampler

Volume 300ml

The Enviro Dipper Set contains everything you need to take surface samples. The set consists of a stainless steel bucket and a hand reel. The Hand Reel is pre-loaded with 50m of polypropylene string and a plastic hook.

The hand reel has a built in ratchet mechanism and brake. This brake ensures that the bucket does not drop until it is released.



- Enviro Dipper Set comprises of:
- Bucket 300ml - 304 stainless steel
 - Hand reel
 - String - 50m, made from polypropylene (PP)

Part No.	Description
5085A-01	Enviro Dipper Set (Hand reel, string and bucket)
Spares	
A725-300	Bucket - 300ml 304 stainless steel



Environmental



Need your Order Quickly?

95% of orders are shipped on the day the order is received.

We have deals with all the major express carriers so we can offer fast cost effective shipping worldwide. We can ship anywhere in Europe and the USA on a next day delivery. The Far East, Middle East and South America is generally 2 – 3 days shipping time.

To check stock levels and confirm lead times please contact us.



Volume 900ml

Disposable Bailer

Popular For Environmental Sampling

The sampler can either be manually pushed into the liquid being sampled or else it can be lowered on the end of a wire. Ideal for sampling from storage silos or well sampling.

For viscous materials use the bailer fitted with an end weight (Part No. 5040W-1000)

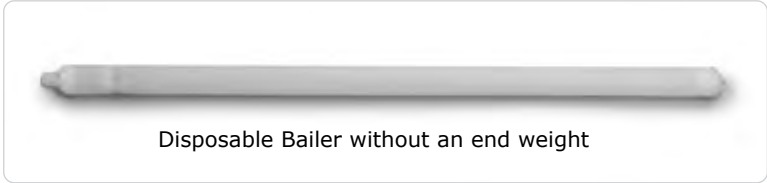

The plastic ball in the end of the sampler is pushed out of the way when the sampler is lowered into the product.

When the sampler is removed the plastic ball seals the sampler.

Note: This sampler is not suitable for high density liquids

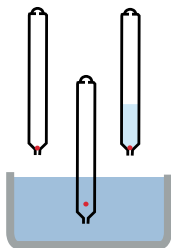

Part No.	Max. Volume	Weighted End	Individually Bagged	Quantity Per Box
5040A-1000	900ml	No	Yes	24
5040W-1000	900ml	Yes	Yes	24

Made from HDPE. 965mm long. 40mm diameter

Hand Reels, Cables & Chain

Hand reels and cables are essential accessories when using sub samplers (Bomb Samplers). The standard heavy duty hand reel is suitable for most situations. However if you are using the sampler in an Ex rated environment use the Hand Reel Ex with the copper cables.

Do not use stainless steel chain in ATEX environments. Check with your site safety officer before using in ATEX environments.



Part No.	Description
5070W-01	Heavy Duty Hand Reel (non-ATEX)
5070D-05	Ex Hand Reel - for ATEX rated environments. Made from conductive plastic. Supplied with earthing leads and clip. Use with copper cable (5070C - which is sold separately)

Part No.	Description
5070S-10	Chain - 316 stainless steel - 10m
5070S-25	Chain - 316 stainless steel - 25m
5070S-50	Chain - 316 stainless steel - 50m
5070D-10	PTFE coated stainless wire - 10m
5070D-25	PTFE coated stainless wire - 25m
5070D-50	PTFE coated stainless wire - 50m

Part No.	Description
5070P-10	Polypropylene - braided cord - 10m
5070P-25	Polypropylene - braided cord - 25m
5070P-50	Polypropylene - braided cord - 50m
5070C-10	Copper - braided cable - 10m
5070C-25	Copper - braided cable - 25m
5070C-50	Copper - braided cable - 50m

New sizes

Sub Sampler Pro

The Best Selling Heavy Duty Liquid Sampler

Volume 500ml to 1000ml

The Sub Sampler Pro (some times called a 'Bomb Sampler') is used throughout the world for both chemical and environmental sampling. Its unique double action means it can sample from a set distance from the bottom of a container or alternatively at a mid point in a container or well for example.

A. Sample from the bottom of a container

- Use a **Lowering Cable**

The Sub Sampler Pro is lowered until the plunger assembly touches the bottom of the container. As the plunger assembly is pushed up the sample is able to enter the device. When the sampler is raised the plunger will drop down and seal the sampler.

Liquid flows in when the sampler hits the bottom

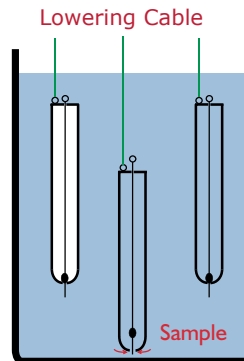

B. Mid-height Sampling

- Use a **Lowering Cable** and a **Control Line**

Lower the Sub Sampler Pro into the liquid. At the required sampling depth pull on the control line to raise the plunger. This will allow the liquid to enter the sampler. Release the control line and the plunger will drop down and seal the sampler.

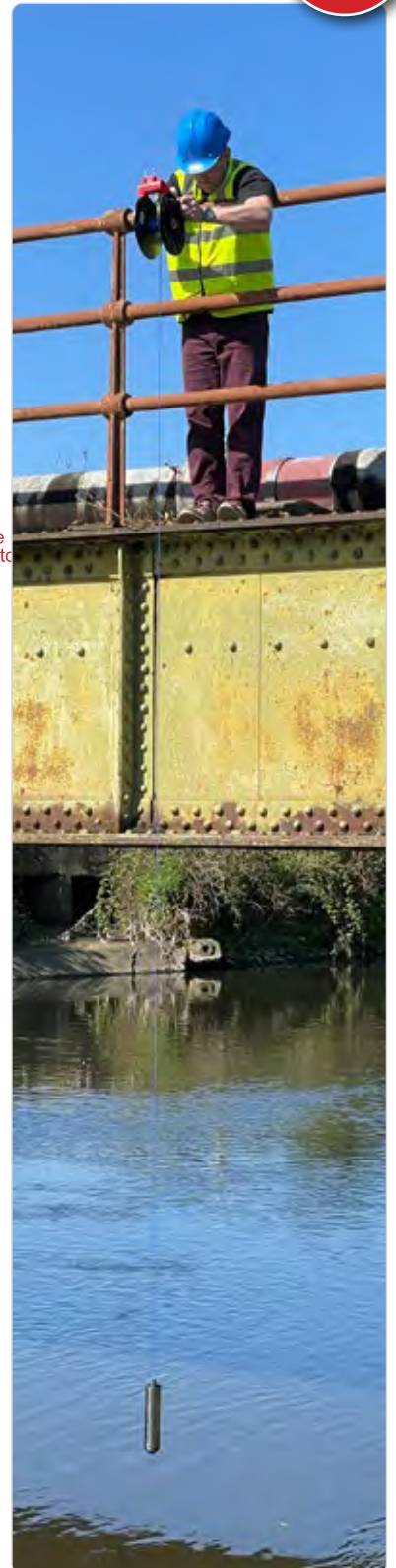
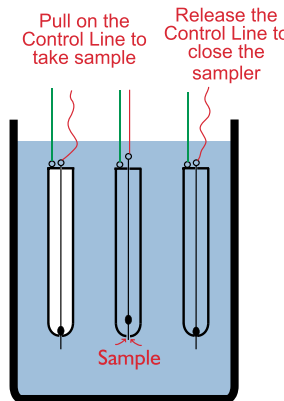

Environmental



- (A) 5072A-500
- (B) 5072A-1000
- (C) 5072B-500
- (D) 5072P-500

Part No.	Nominal Volume	Material	Diameter x Length	Ex Rated
5072A-500	500ml	Nickel plated brass	52 x 425mm	No
5072A-1000	1000ml	Nickel plated brass	75 x 438mm	Yes*
5072B-500	500ml	316L Stainless steel	66 x 300mm	No
5072P-500	500ml	PTFE	70 x 371mm	No

* Make sure the sampler is properly earthed (grounded) use the Ex Hand Reel (5070D-05) and Copper cable (5070C) Don't forget to order your Hand Reel and Cable - see page 124

Deep Water Sampler

Large volume environmental sampler

The Deep Water Sampler is ideal for liquid and water sampling. It can be used in tanks, wells, containers, rivers and the sea.

The sampler has a flap valve at the top and bottom. As the sampler is lowered the water flows in through the bottom flap and out through the top. When the sampling depth is reached the flap valves automatically close. As the sampler is raised the pressure of the water will keep the top flap closed, this will prevent any new water from entering the sampler.

To discharge the liquid simply open the valve on the side.

- Graduated
- Supplied with 15m rope
- Transparent so its easy to visually inspect what has been sampled
- Made from robust plexiglass
- Ideal for chemical and environmental sampling
- Stratified sampling is quick and easy

Volume 1000ml to 2500ml

New
Sizes



Part No.	Nominal Volume	Diameter	Height	Material
5079A-1000	1000ml	100mm	300mm	Plastic & Plexiglass
5079A-2500	2500ml	130mm	340mm	Plastic & Plexiglass

Water Level Meter

Accurately measure the depth of water

The Water Level Meter allows you to accurately determine the depth of the water in a well, tank or borehole. Simply lower the sensor into tank and the presence of water is indicated by a buzzer, the LED and electricity meter.

- Corrosion resistant 316 stainless steel probe
- Sensor on an easy to read measuring tape
- 9V battery (supplied)
- Complete with reel

Part No.	Max. Depth of Measurement	Weight
K102-30	30m	3.5kg
K102-50	50m	4.5kg
K102-100	100m	6.5kg
K102-200	200m	10kg

New



In-Stream Sampler

The In-Stream Sampler is a useful piece of equipment for taking samples from a product that is flowing. Alternatively it can be used to take samples directly from containers or vessels.

The In-Stream Sampler is made from robust 316L stainless steel. It can be used for sampling both powders and liquids.



- Multi purpose sampler
- 316L stainless steel
- Crevice free interior
- Available from stock
- Polished finish

Part No.	Nominal Volume	Max. Diameter of Cup	Handle Length
A996-500	500ml	95mm	1000mm
Accessories	Storage Cases	See page 176	
	XRF Certification	See page 118	

Immersion Cylinder Sampler

Immersion Cylinders are designed to take liquid samples

Volume 300ml to 1000ml

New

Immersion Cylinders are designed to take liquid samples from open water as well as tanks, drums, wells and large storage containers. Immersion Cylinders are available made from either 304 stainless steel or from brass. They are available in a range of sizes.

The Immersion Cylinder is designed to be easy to clean. Both end of the sampler unscrew for easy cleaning.

Two Methods of Sampling

1. When the sampler reaches the bottom of the tank the sampler automatically opens.
2. When the sampler is mid-level, a second control line is used to open the sampler

Note: Hand reels and cables are sold separately. See page 124



Part No.	Volume	Diameter	Height	Material
5132S-300	300ml	70mm	129mm	304 ss
5132S-500	500ml	70mm	168mm	304 ss
5132S-1000	1000ml	70mm	303mm	304 ss
5132B-300	300ml	70mm	125mm	Brass
5132B-500	500ml	70mm	183mm	Brass
5132B-1000	1000ml	70mm	300mm	Brass

Environmental

Dipping Bottle

Take samples from open water as well tanks, drums, wells

Volume 300ml to 1000ml

New

Dipping Bottles are designed to take samples from open water as well as tanks, drums, wells and large storage containers. They are available made from either 304 stainless steel or from brass and they are available in a range of sizes.

The operator lowers the Dipping Bottle until the sampling depth is reached. The operator then pulls sharply upwards and this pulls the aluminium stopper out of the bottle, the liquid can then flow in.

- Bottles - made from 304 stainless steel or brass
- Lids - made from aluminium

Note: Hand reels and cables are sold separately. See page 124



Part No.	Volume	Diameter	Height	Material
5332S-300	300ml	75mm	153mm	304 ss & Aluminium
5332S-500	500ml	75mm	207mm	304 ss & Aluminium
5332S-1000	1000ml	75mm	325mm	304 ss & Aluminium
5332B-300	300ml	62mm	162mm	Brass & Aluminium
5332B-500	500ml	62mm	240mm	Brass & Aluminium
5332B-1000	1000ml	77mm	300mm	Brass & Aluminium

Cereal Trier (Slot Sampler)

Volume 45ml to 2370ml

The Cereal Trier is a multilevel slot sampler that is ideal for sampling grains, rice, cereals, seeds, small nuts etc. These samplers are made from hygienic 316L stainless steel or light-weight anodized aluminium. They are available in a range of lengths and widths.

- Multilevel sampler of grains, cereals and powders
- 316L stainless steel or anodized aluminium manufacture
- Robust design
- Available from stock



EASY TO USE

Slot Samplers are easy to use. They consist of an inner and outer tube. Close the sampler and the push it into the product. When fully inserted turn the handle to open the sampler - this allows the product to enter the sampler. Close and remove sampler. Invert the sampler to empty the sample through the handle into a collection vessel.



Stainless Steel Slot Samplers

Part No.	Nominal Length	Outer Diameter	Maximum Sample Volume	Number of Sampling Slots	Material
1210A-300	300mm	25mm	45ml	3	316L stainless steel
1210A-600	600mm	25mm	110ml	3	316L stainless steel
1210A-1000	1000mm	25mm	190ml	4	316L stainless steel
1210A-1500	1500mm	25mm	300ml	5	316L stainless steel
1210A-2000	2000mm	25mm	370ml	5	316L stainless steel
1210K-1000	1000mm	40mm	750ml	3	316L stainless steel
1210K-1500	1500mm	40mm	1000ml	4	316L stainless steel
1210K-2000	2000mm	40mm	1300ml	4	316L stainless steel

Aluminium Slot Samplers

Part No.	Nominal Length	Outer Diameter	Maximum Sample Volume	Number of Sampling Points	Material
1610A-600	600mm	25mm	80ml	3	Anodized Aluminium
1610A-1000	1000mm	25mm	135ml	5	Anodized Aluminium
1610A-1500	1500mm	25mm	190ml	7	Anodized Aluminium
1610A-2000	2000mm	25mm	245ml	7	Anodized Aluminium
1610A-2500	2500mm	25mm	350ml	10	Anodized Aluminium
1210J-900	900mm	50mm	890ml	3	Anodized Aluminium
1210J-1500	1500mm	50mm	1630ml	5	Anodized Aluminium
1210J-2500	2500mm	50mm	2370ml	7	Anodized Aluminium



Grain Spear

Grain Sampler with Spiral Pockets

Volume 340ml to 860ml



Highly representative sampling is quick and easy with our aluminium Sample Spear.

The spiral position of the pockets give superior sampling results. This means the bottom pocket opens and fills first giving a more representative sample.

The sampler is particularly suited for larger powders, granule and grain sampling. This can be from IBC, kegs, silos, railway trucks, ships and almost all applications

The lightweight aluminium construction means even the long samplers are easy to operate and handle. The tip is fixed permanently so it can not become loose and get lost.



1924H-35

- Anodised Aluminium
- Robust Construction
- Available from stock. Fast delivery worldwide



Environmental

Part No.	Nominal Length	Diameter	No. of Sampling Slots	Max. Sample Volume	Material
1942A-1000	1000mm	35mm	4	340ml	Aluminium
1942A-1500	1500mm	35mm	6	525ml	Aluminium
1942A-2000	2000mm	35mm	8	700ml	Aluminium
1942A-2500	2500mm	35mm	10	860ml	Aluminium
1942H-35	Heavy Duty Handle for 35mm diameter samplers (extra leverage)				
8020J-1100	Cleaning Brush. 1100mm long				
8020J-1600	Cleaning Brush. 1600mm long				
8020J-2100	Cleaning Brush. 2100mm long				

Temperature Probe

Long reach digital temperature probe

The Temperature Probe is ideal for measuring the temperature of products deep within silos and tanks. The Temperature Probe consists of a robust, lightweight aluminium probe with a clear easy read, battery operated display.

- Clear digital readout in °C or °F
- 2m length, 16mm diameter
- Aluminium probe
- Operational Range -10 to +50°C (14 to 122°F)
- Supplied with 4 x AA (LR6) batteries



New

Part No.	Description
K101-2000F	Temperature Probe 2m - Aluminium

Soil Samplers



Our range of Soil Samplers are made from durable stainless steel. The range includes a number of different tips that makes them suitable for most soil types.

Some soil samplers are supplied with the following features:

- Adjustable foot rest ideal for use with hard soil
- Sample ejector to aid the removal of the sample

Environmental

Soil Sampler



New

Part No.	Nominal Length	Outer Diameter	Material
1621A-1000	1000mm	50mm	Stainless steel

Soil Sampler Screw



- Highly efficient screw



New

Part No.	Nominal Length	Outer Diameter	Material
1625A-1000	1000mm	45mm	Stainless steel

Soil Sampler Auger



New

Part No.	Nominal Length	Outer Diameter	Material
1624A-1050	1000mm	50mm	Stainless steel

Soil Sampler Scoop with Foot Rest



- Adjustable foot rest
- Built in sample ejector



New

Part No.	Nominal Length	Outer Diameter	Material
1623A-538	500mm	38mm	Stainless steel
1623A-1050	1000mm	50mm	Stainless steel

Soil Cup Sampler



New

Part No.	Nominal Length	Outer Diameter	Material
1622A-1000	1000mm	60mm	Stainless steel

Environmental

Soil Sampler Pro (316L ss)



- Sturdy foot rests
- 316L stainless steel construction



Part No.	Nominal Length	Outer Diameter	Material
1620A-01	1000mm	25mm	316L ss

Stainless Sample Splitter

For Environmental Use



Sample Splitters (Riffles) are used when dividing and reducing the bulk sample. They are ideal for food, environmental and chemical use.

Place the bulk sample into the hopper and the evenly divided product is collected in the two receiving boxes.

It is recommended that the width of the slots is 2.5 to 3 times bigger than the diameter of the largest particle being split.

- Manufactured in stainless steel
- Available in different sizes from stock
- No power required - can be used in the laboratory or on site
- Supplied with 2 stainless steel receiving boxes



Part No.	Number of Slots	Slot Width	Material
8601S-06	16 slots	6mm	Stainless Steel
8601S-10	16 slots	10mm	Stainless Steel
8601S-20	12 slots	20mm	Stainless Steel
8601S-30	12 slots	30mm	Stainless Steel

Note: Due to the method of construction we do not recommend this product for GMP pharmaceutical use.

Soil Sampling Accessories



Sample Bags

See Pages 194-195



Sample Bottles

See Pages 188-193



Scraper Spatulas

See Pages 156-161



Cleaning Brushes

See Page 177



Metal Detectable

New Range





- X-Ray Visible**
- Metal Detectable**
- Food Safe**

- Manufactured and packed in a Cleanroom for superior cleanliness
- Every product is individually wrapped
- Made from FDA, EC 1935/2004 & EU 10/2011 conforming Polypropylene (PP)
- BSE/TSE free
- Highly visible blue colour
- Large stocks for fast delivery worldwide
- DURABLE - can be used straight from the bag or repeatedly used

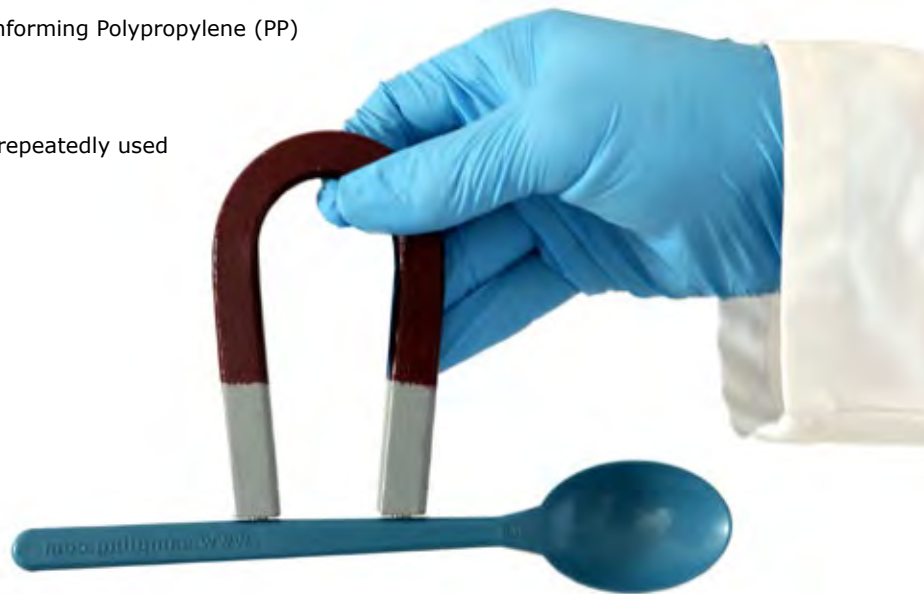

How it's done

The Sampling Systems Range of metal detectable products are manufactured from a special mix of three food safe ingredients:

Polypropylene (PP)
A special metal detectable filler
A blue colouring

All three ingredients are thoroughly mixed before the products are injection moulded. This means that every part of the product is both metal detectable and seen by X-ray visible.

All the products in our Metal Detectable range are manufactured under the same stringent conditions as our single use SteriWare® products.

Metal Detectable Scoop

Volume 30ml to 2500ml



Part No.	Nominal Volume	Colour	Material	Pack Quantity
M1000B-30	30ml	Blue	PP	4
M1000B-60	60ml	Blue	PP	4
M1000B-125	125ml	Blue	PP	4
M1000B-250	250ml	Blue	PP	4
M1000B-500	500ml	Blue	PP	4
M1000B-1000	1000ml	Blue	PP	4
M1000B-2500	2500ml	Blue	PP	4

Metal Detectable Long Handled Scoop

Volume 100ml



Part No.	Nominal Volume	Overall Length	Overall Width	Material	Pack Quantity
M1040B-100	100ml	390mm	50mm	Blue PP	4

Metal Detectable V-Spatula



Part No.	Blade Length	Overall Length	Material	Pack Quantity
M1010B-150	150mm	248mm	Blue PP	4
M1010B-250	250mm	345mm	Blue PP	4

Metal Detectable Spoon

Volume 10ml



Part No.	Nominal Volume	Overall Length	Material	Pack Quantity
M1006B-10	10ml	185mm	Blue PP	4

Metal Detectable Volumetric Spoon

Volume 2.5ml



Part No.	Flat Fill Volume	Bowl Diameter	Overall Length	Material	Pack Quantity
M1030B-25	2.5ml	23mm	158mm	Blue PP	4

Metal Detectable Powder Funnel



Part No.	Top Diameter	Spout Diameter	Material	Pack Quantity
M1051B-200	200mm	43mm	Blue PP	4

Metal Detectable Liquid Funnel



Part No.	Top Diameter	Spout Diameter	Overall Height	Material	Pack Quantity
M1023B-100	100mm	10mm	105mm	Blue PP	4

Metal Detectable Long Handled Spoon

Volume 20ml



Part No.	Flat Fill Volume	Handle Length	Material	Pack Quantity
M1036B-20	20ml	285mm	Blue PP	4

Metal Detectable Jug

Volume 500ml to 1000ml

New



Part No.	Nominal Volume	Diameter	Height	Material	Pack Quantity
M1044B-500	500ml	90mm	130mm	Blue PP	4
M1044B-1000	1000ml	120mm	170mm	Blue PP	4

Metal Detectable Ladle

Volume 50ml

New



Part No.	Nominal Volume	Diameter	Length	Material	Pack Quantity
M1033B-50	50ml	48mm	260mm	Blue PP	4

Metal Detectable Micro Spatula

Volume 2ml

New



Part No.	Nominal Volume	Blade Width x Length	Overall Length	Material	Pack Quantity
M1013B-170	2ml	13 x 40mm	170mm	Blue PP	4

Metal Detectable Bottle

Volume 250ml to 500ml

New



Part No.	Nominal Volume	Overall Height	Outer Diameter	Material	Pack Quantity
M1047B-250	250ml	88mm	76mm	Blue PP	4
M1047B-500	500ml	106mm	94mm	Blue PP	4

Metal Detectable



Metal Detectable Pallet Knife



Part No.	Blade Length	Blade Width	Overall Length	Material	Pack Quantity
M1016B-200	200mm	45mm	310mm	Blue PP	4

Metal Detectable Scraper



Part No.	Blade Length	Blade Width	Overall Length	Material	Pack Quantity
M1019B-110	110mm	110mm	225mm	Blue PP	4

Metal Detectable

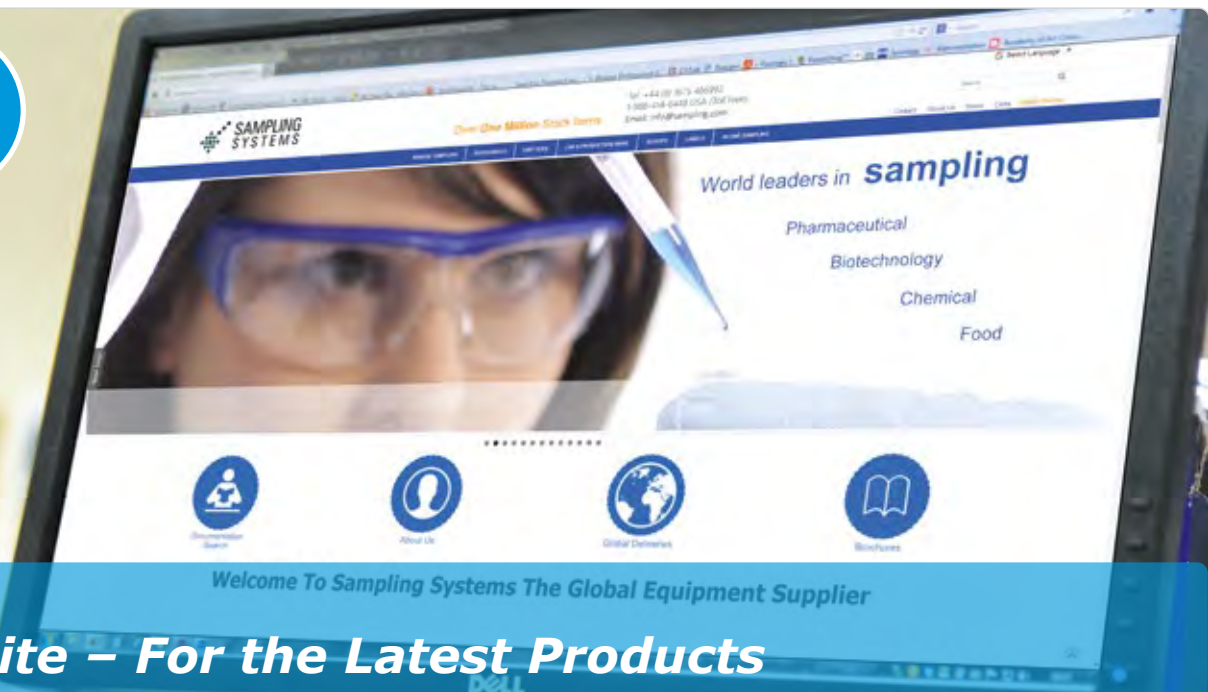

Website – For the Latest Products

Our web site is constantly being updated with the latest products.
For more info please see www.sampling.com

Accessories



Open PharmaScoops®

Volume 250ml to 4000ml



Open PharmaScoops are a popular alternative to our best selling PharmaScoops (page 141). Open PharmaScoops are designed to be easy to clean due to their crevice free design. They have a broad ergonomic handle which makes them comfortable to use even when wearing gloves.

Huge stocks for fast worldwide delivery.

- Heavy duty construction
- 316L stainless steel
- Crevice free
- Bright polish
- Rounded corners for easy cleaning
- GMP correct



Part No.	Nominal Capacity	Width	Body Length	Overall Length	Material
A336-250	250ml	100mm	160mm	280mm	316L stainless steel
A336-500	500ml	100mm	195mm	310mm	316L stainless steel
A336-750	750ml	125mm	205mm	320mm	316L stainless steel
A336-1000	1000ml	130mm	270mm	390mm	316L stainless steel
A336-1500	1500ml	150mm	235mm	350mm	316L stainless steel
A336-2000	2000ml	155mm	290mm	410mm	316L stainless steel
A336-4000	4000ml	205mm	310mm	430mm	316L stainless steel

PharmaScoops® (316L ss)

Volume 10ml to 5000ml



PharmaScoops are high quality stainless steel scoops. They are ideal for dispensing and for sampling.

- High quality scoops
- Heavy duty construction
- 316L stainless steel
- Crevice free
- Bright polish
- Rounded corners for easy cleaning
- GMP correct



PharmaScoops are a worldwide best seller in the pharmaceutical, food and chemical industries.

Accessories

Part No.	Nominal Capacity	Body Diameter	Body Length	Overall Length	Material
A316-10	10ml	25mm	45mm	75mm	316L ss
A316-50	50ml	38mm	70mm	110mm	316L ss
A316-100	100ml	50mm	100mm	180mm	316L ss
A316-250	250ml	75mm	120mm	235mm	316L ss
A316-500	500ml	95mm	140mm	240mm	316L ss
A316-750	750ml	95mm	210mm	330mm	316L ss
A316-1000	1000ml	110mm	235mm	340mm	316L ss
A316-1250	1250ml	125mm	195mm	305mm	316L ss
A316-1700	1700ml	135mm	230mm	355mm	316L ss
A316-2500	2500ml	185mm	215mm	320mm	316L ss
A316-5000	5000ml	220mm	230mm	355mm	316L ss

Scorpion PharmaScoops®

Volume 1500ml to 2000ml



- Heavy duty construction
- 316L stainless steel
- Hygienic crevice free construction
- Satin finish
- Rounded corners for easy cleaning

Part No.	Nominal Capacity	Body Width	Body Length	Overall Height
A346-1500	1500ml	155mm	260mm	130mm
A346-2000	2000ml	165mm	300mm	150mm

Long Handle PharmaScoops®

Volume 10ml to 1000ml



- Extra Long handle
- Crevice free
- 316L stainless steel construction
- Rounded corners for easy cleaning
- GMP correct



Part No.	Nominal Capacity	Body Diameter	Body Length	Handle Length
A396-10	10ml	25mm	45mm	300mm
A396-50	50ml	38mm	70mm	300mm
A396-100	100ml	50mm	100mm	300mm
A396-500	500ml	95mm	140mm	600mm
A396-1000	1000ml	110mm	235mm	600mm

Weighing PharmaScoops®

Volume 500ml

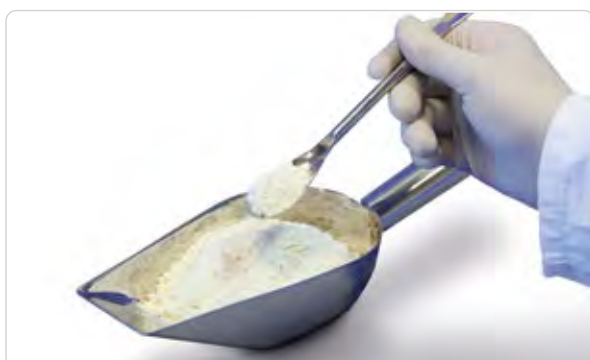

- Free-standing scoop, ideal for use with weighing scales
- 316L stainless steel
- Rounded corners
- Crevice free construction
- Satin finish
- Robust handle

Part No.	Nominal Capacity	Maximum Width	Body Length	Overall Length
A376-500	500ml	110mm	205mm	320mm

Square PharmaScoops®

Volume 1500ml



- Heavy duty construction
- Made from 316L stainless steel
- Crevice free
- Satin finish
- Rounded corners for easy cleaning
- GMP correct

Part No.	Nominal Capacity	Width	Body Length	Overall Length
A366-1	1500ml	160mm	190mm	315mm

GMP Scoop

High quality, heavy duty powder scoops with improved ergonomics

Volume 750ml to 5000ml



GMP PharmaScoops are suitable for the most demanding of applications. The fully radiused body ensures they are easy to clean and minimises the risk of cross contamination.

For extra heavy duty work the GMP PharmaScoop is available with an optional Top Handle to improve the ergonomics.

- Heavy duty construction
- 316L stainless steel
- Hygienic crevice free construction
- Bright Polish
- Optional Top Handle
- Rounded corners for easy cleaning



Fully Welded

The scoop is fully welded with all the critical welds polished smooth



Top Handle (Optional)

Gives extra stability and leverage when scooping large volumes

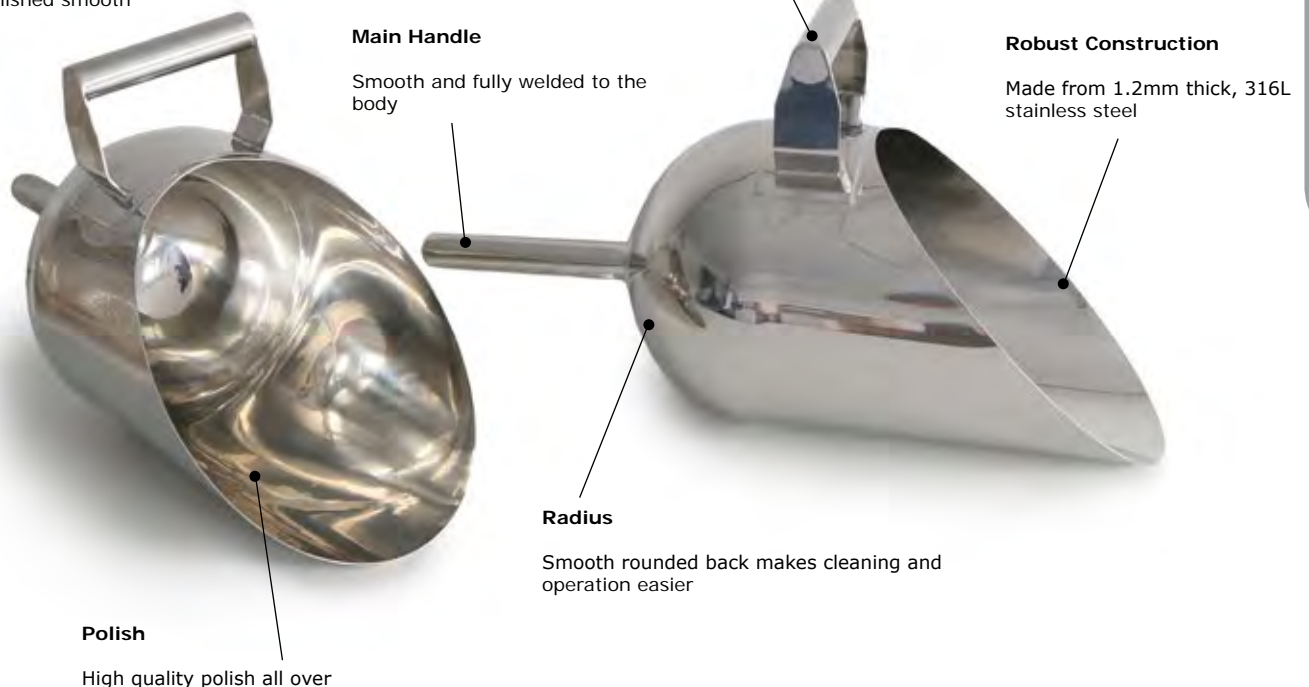

Part No.	Nominal Capacity	Top Handle	Body Diameter	Body Length	Overall Length	Material
A606-750	750ml	No	98mm	180mm	333mm	316L ss
A606-1500	1500ml	No	125mm	210mm	365mm	316L ss
A606-3000	3000ml	No	160mm	270mm	420mm	316L ss
A606-5000	5000ml	No	195mm	350mm	500mm	316L ss
A776-3000	3000ml	Yes	160mm	270mm	420mm	316L ss
A776-5000	5000ml	Yes	195mm	350mm	500mm	316L ss

SteriWare PharmaScoops®



SteriWare PharmaScoops® are high quality, single use, disposable plastic scoops. All SteriWare PharmaScoops® are manufactured and packed in a Cleanroom. They are widely used in the pharmaceutical and food industries all over the world.

SteriWare PharmaScoops® are ideal for use with potent drugs as well as highly coloured or perfumed products.

- Manufactured and packed in a Cleanroom to ensure cleanliness
- Individually wrapped
- Made from tough, virgin PS, HDPE or PP (FDA acceptable, EU 10/2011 and EC 1935/2004)
- Available non-sterile or pre-sterilised (validated procedure using gamma irradiation)
- Available from stock

For the complete range please see pages 10-14

Filling Scoop (316L ss)

Volume 750ml



The Filling Scoop can be used to fill bags and bottles directly through the handle of the scoop. The scoop has a special rounded funnel shape to help the material flow through the handle. This Filling Scoop is suitable for use with most free-flowing powders and granules.

- Empty scoop through the handle
- Heavy duty construction
- 316L stainless steel
- Hygienic crevice free construction
- Bright polish
- Rounded corners for easy cleaning

Part No.	Nominal Capacity	Width	Body Length	Overall Length
A436-750	750ml	101mm	183mm	313mm



Scorpion Scoop Eco

Volume 1000ml

- 304 stainless steel
- Satin finish
- Suitable for general, light duty use

Part No.	Nominal Capacity	Body Width	Body Length	Overall Height
A334-1000	1000ml	120mm	232mm	200mm



PTFE Scoops

Volume 100ml to 500ml



- Crevice free
- PTFE construction (FDA acceptable and USP Class VI)
- Rounded corners for easy cleaning
- GMP correct

Part No.	Nominal Capacity	Body Diameter	Body Length	Overall Length
A333-100	100ml	65mm	95mm	195mm
A333-500	500ml	100mm	140mm	265mm

Industrial Scoops

Volume 100ml to 1000ml



- Light duty construction
- Stainless steel
- Fully welded construction

Part No.	Nominal Capacity	Body Width	Body Length	Overall Length
A643-100	100ml	65mm	117mm	205mm
A643-200	200ml	85mm	140mm	225mm
A643-300	300ml	90mm	170mm	275mm
A643-500	500ml	105mm	185mm	290mm
A643-1000	1000ml	125mm	200mm	302mm

Economy Scoops

Volume 120ml to 2000ml



- Light duty construction
- 304 stainless steel

Important Note - Economy Scoops are not crevice free and are therefore not suitable for GMP applications

Part No.	Nominal Capacity	Diameter	Overall Length
A304-120	120ml	50mm	195mm
A304-450	450ml	75mm	255mm
A304-1000	1000ml	120mm	315mm
A304-1500	1500ml	120mm	345mm
A304-2000	2000ml	160mm	365mm

Ice Scoops

Volume 100ml



- Perforated to allow excess water to flow away
- 304 stainless steel

Part No.	Nominal Capacity	Body Diameter	Body Length	Overall Length
A314-100	100ml	50mm	100mm	180mm

SteriWare® Ladle

Volume 50ml to 100ml

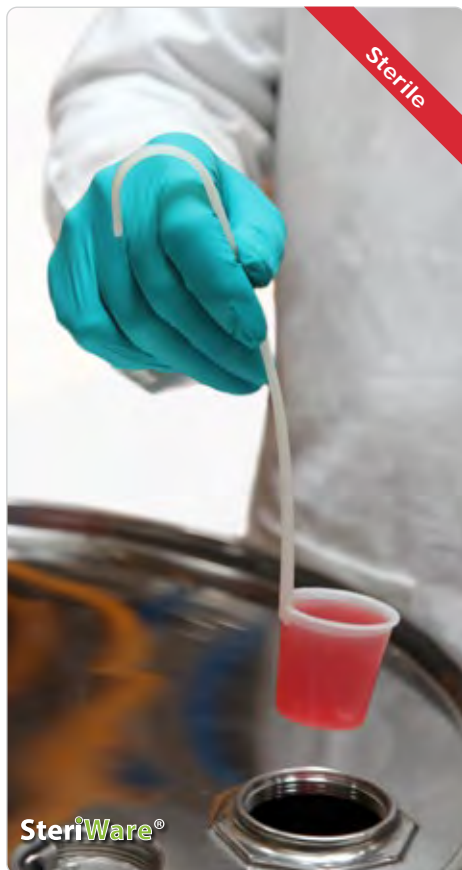

The SteriWare® Ladle is ideal for the surface sampling of liquids. They can be used straight from the bag; simply unwrap and use.

The one piece design has been specially constructed to go through standard 2" lid bungs which are commonly found on barrels and kegs.

- Manufactured and packed in a Cleanroom
- Individually Bagged
- FDA & EU 10/2011 Conforming Materials
- BSE/TSE Free
- Full Batch Traceability
- Available Sterile (gamma irradiated)
- Available from stock



Part No.	Nominal Volume	Sterile	Material	Colour	Box Quantity
8053H-50	50ml	No	HDPE	Natural	40
8053H-50S	50ml	Yes	HDPE	Natural	40
8053P-100	100ml	No	PP	Natural	40
8053P-100S	100ml	Yes	PP	Natural	40
8053B-50	50ml	No	PP	Blue	40
8053B-50S	50ml	Yes	PP	Blue	40

Stainless Ladle

Volume 50ml to 200ml



- Satin finish
- 304 or 316L stainless steel
- All stainless steel construction
- Crevice free construction

Part No.	Nominal Volume	Stainless Steel	Bowl Diameter	Handle Length
A326-150	150ml	316L	88mm	370mm
A324-50	50ml	204	62mm	215mm
A324-120	120ml	204	82mm	270mm
A324-150	150ml	204	92mm	270mm
A324-200	200ml	204	101mm	270mm

Metal Detectable Ladle

Volume 50ml



- Manufactured and packed in a Cleanroom
- Individually wrapped
- Made from FDA, EC 1935/2004 & EU 10/2011 conforming Polypropylene (PP)
- BSE/TSE free
- Highly visible blue colour
- Large stocks for fast delivery worldwide

Part No.	Nominal Volume	Diameter	Colour	Material of Construction	Pack Quantity
M1033B-50	50ml	48mm	Blue	PP	4

Stainless Dippers (316Lss)

Volume 50ml to 500ml

- 316L stainless steel construction
- Fully welded
- Satin finish
- Range of volumes and handle lengths



Part No.	Nominal Volume	Overall Length	Outside Cup Diameter
5005A-50	50ml	600mm	32mm
5005A-100	100ml	600mm	39mm
5005A-250	250ml	600mm	63mm
5005A-500	500ml	600mm	76mm
5005B-50	50ml	1000mm	32mm
5005B-100	100ml	1000mm	39mm
5005B-250	250ml	1000mm	63mm
5005B-500	500ml	1000mm	76mm
5005C-50	50ml	1500mm	32mm
5005C-100	100ml	1500mm	39mm
5005C-250	250ml	1500mm	63mm
5005C-500	500ml	1500mm	76mm



New sizes

Accessories

In-Stream Sampler

Volume 500ml



The In-Stream Sampler is a useful piece of equipment for taking samples from a product that is flowing. Alternatively it can be used to take samples directly from containers or vessels.

The In-Stream Sampler is made from robust 316L stainless steel. It can be used for sampling both powders and liquids.

- Multi purpose sampler
- 316L stainless steel
- Crevice free interior
- Available from stock
- Polished finish

Part No.	Nominal Volume	Max. Cup Diameter	Handle Length
A996-500	500ml	95mm	1000mm



Pallet Knives and Scrapers



SteriWare® Pallet Knife

- Manufactured and packed in a Cleanroom
- Individually Bagged
- FDA, EC 1935/2004 & EU 10/2011 Conforming Materials
- BSE/TSE Free
- Full Batch Traceability
- Available Sterile (gamma irradiated)



HDPE - Natural

Part No.	Blade Length	Blade Width	Overall Length	Sterile	Box Quantity
8175H-150	150mm	40mm	260mm	No	100
8175H-150S	150mm	40mm	260mm	Yes	100
8175H-200	200mm	45mm	310mm	No	100
8175H-200S	200mm	45mm	310mm	Yes	100



SteriWare® Scraper

- Manufactured and packed in a Cleanroom
- Individually Bagged
- FDA, EC 1935/2004 & EU 10/2011 Conforming Materials
- BSE/TSE Free
- Full Batch Traceability
- Available Sterile (gamma irradiated)



HDPE - Natural

Part No.	Blade Length	Blade Width	Overall Length	Sterile	Box Quantity
8785H-75	75mm	75mm	190mm	No	100
8785H-75S	75mm	75mm	190mm	Yes	100
8785H-110	110mm	110mm	225mm	No	100
8785H-110S	110mm	110mm	225mm	Yes	100



PP (Polypropylene) - BLUE

Part No.	Blade Length	Blade Width	Overall Length	Sterile	Box Quantity
8785B-75	75mm	75mm	190mm	No	100
8785B-75S	75mm	75mm	190mm	Yes	100





GMP Pallet Knives - Crevice Free

- Crevice free
- All stainless steel construction
- Satin finish



Part No.	Nominal Blade Length	Blade Width	Overall Length
A123-100	100mm	20mm	188mm
A123-150	150mm	25mm	255mm
A123-200	200mm	31mm	325mm
A123-250	250mm	37mm	380mm
A123-300	300mm	51mm	442mm
A123-350	350mm	51mm	490mm

Stainless Pallet Knives

- All stainless steel construction
- Satin finish

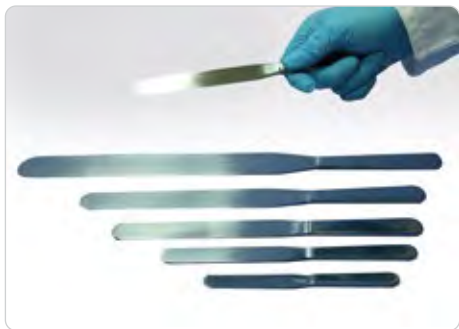

Part No.	Blade Length	Blade Width	Overall Length
A330-100	100mm	20mm	200mm
A330-130	130mm	20mm	228mm
A330-150	150mm	25mm	247mm
A330-200	200mm	30mm	300mm
A330-250	250mm	35mm	360mm
A330-300	300mm	40mm	423mm
A330-350	350mm	45mm	473mm

Pallet Knife with Plastic Handle

- Stainless steel blade with plastic handle
- Satin finish



Part No.	Nominal Blade Length	Blade Width	Overall Length
A200-100	100mm	20mm	190mm
A200-200	200mm	30mm	310mm
A200-300	300mm	35mm	415mm

Pallet Knife with Wooden Handle

- Stainless steel blade with wooden handle
- Satin finish



Part No.	Nominal Blade Length	Blade Width	Overall Length
A201-100	100mm	18mm	190mm
A201-150	150mm	23mm	252mm
A201-200	200mm	30mm	330mm
A201-300	300mm	35mm	415mm

Stainless Steel Scrapers

- Crevice free, stainless steel construction
- Satin finish



Part No.	Stainless Steel	Blade Width	Overall Length
A350-75	420S45	75mm	232mm
A350-100	420S45	100mm	277mm
A656-100	316L	110mm	235mm

Accessories

Funnel Disposable & reusable



Powder Funnel (316L stainless steel)

New sizes



- 316L stainless steel
- Satin finish
- Tri ferrule fitting at spout base (BS4825-3)

Part No.	Nominal Top Diameter	Tri Ferrule Size	Height	Stainless Steel
A716-100	100mm	1.5"	107mm	316L
A716-200	200mm	1.5"	232mm	316L
A716-300	300mm	2"	310mm	316L
A716-400-2	400mm	2"	396mm	316L
A716-400-4	400mm	4"	352mm	316L

Powder Funnel (Plastic)



- Ideal for loading powder into drums, containers or kegs
- Crevice Free

Part No.	Nominal Top Diameter	Outlet Diameter	Material
8023P-100	100mm	20mm	PP
8023P-150	150mm	27mm	PP
8023H-200	200mm	43mm	HDPE
8023H-250	250mm	50mm	HDPE
8023P-350	350mm	52mm	PP

SteriWare® Powder Funnel

New sizes



- Individually bagged
- FDA and EC conforming polymers
- Available sterile and non-sterile

Part No.	Nominal Top Diameter	Spout Diameter	Sterile	Material	Box Quantity
8111H-50	50mm	18mm	No	HDPE	50
8111H-50S	50mm	18mm	Yes	HDPE	50
8111H-100	100mm	23mm	No	HDPE	20
8111H-100S	100mm	23mm	Yes	HDPE	20
8111H-200	200mm	43mm	No	HDPE	10
8111H-200S	200mm	43mm	Yes	HDPE	10
8111H-250	250mm	54mm	No	HDPE	TBC
8111H-250S	250mm	54mm	Yes	HDPE	TBC
8111P-350	350mm	52mm	No	PP	8
8111P-350S	350mm	52mm	Yes	PP	8

SteriWare® Liquid Funnel

- Manufactured and packed in a Cleanroom
- Individually Bagged
- FDA & EU 10/2011 Conforming Materials
- BSE/TSE Free
- Full Batch Traceability
- Available Sterile (gamma irradiated)



Part No.	Nominal Top Diameter	Outlet Diameter	Colour	Sterile	Material	Box Quantity
8370H-50	50mm	8mm	Natural	No	HDPE	100
8370H-50S	50mm	8mm	Natural	Yes	HDPE	100
8370H-100	100mm	11mm	Natural	No	HDPE	50
8370H-100S	100mm	11mm	Natural	Yes	HDPE	50
8370H-200	200mm	19mm	Natural	No	HDPE	10
8370H-200S	200mm	19mm	Natural	Yes	HDPE	10
8370H-250	250mm	30mm	Natural	No	HDPE	TBC
8370H-250S	250mm	30mm	Natural	Yes	HDPE	TBC
8370B-100	100mm	11mm	Blue	No	PP	50
8370B-100S	100mm	11mm	Blue	Yes	PP	50

New sizes

Liquid Funnel



- 304 stainless steel
- Satin finish
- Fluted spout to aid product discharge

Part No.	Nominal Top Diameter	Outlet Diameter	Height
A244-50	60mm	14mm	65mm
A244-100	100mm	12mm	120mm
A244-120	120mm	13mm	140mm
A244-150	150mm	20mm	170mm
A244-200	200mm	20mm	205mm
A244-250	240mm	20mm	235mm
A244-310	310mm	20mm	325mm

New sizes

Liquid Funnel (Plastic)



- Food grade polymers
- Crevice Free
- Re-usable

Part No.	Nominal Top	Outlet Diameter	Height	Material
8022P-50	50mm	8mm	56mm	PP
8022P-100	100mm	11mm	103mm	PP
8022P-200	200mm	19mm	180mm	PP
8022H-250	250mm	30mm	240mm	HDPE
8022P-350	350mm	52mm	264mm	PP

New sizes

PTFE Funnel



- Crevice free interior
- Heavy wall construction

Part No.	Nominal Top Diameter	Outlet Diameter	Height
A105-30	30mm	8mm	49mm
A105-50	50mm	10mm	82mm
A105-70	70mm	12mm	110mm
A105-100	100mm	14mm	140mm
A105-150	150mm	18mm	195mm

Funnel With Strainer



Our Funnels with strainer are ideal for removing large particles. The built in strainer has 4mm diameter holes and so is ideal for removing large particles and debris from your sample.

- 304 stainless steel
- Polished

Part No.	Nominal Top Diameter	Height	Hole Size	Material
A904-165	165mm	165mm	4mm	304 ss

Industrial Liquid Funnel



- 304 stainless steel
- Straight spout
- Satin polish

Part No.	Nominal Top Diameter	Outlet Diameter	Material
A164-60	60mm	12mm	304 ss
A164-110	110mm	16mm	304 ss
A164-150	150mm	22mm	304 ss
A164-180	180mm	22mm	304 ss



Metal Detectable Powder Funnel



- Manufactured and packed in a Cleanroom
- Individually Bagged
- Made from FDA, EC 1935/2004 & EU 10/2011 conforming PP
- BSE/TSE Free
- Full Batch Traceability

Part No.	Top Diameter	Spout Diameter	Sterile	Pack Quantity
M1051B-200	200mm	40mm	No	4



Metal Detectable Liquid Funnel



- Manufactured and packed in a Cleanroom
- Individually wrapped
- Made from FDA, EC 1935/2004 & EU 10/2011 conforming Polypropylene (PP)
- BSE/TSE free
- Highly visible blue colour
- Large stocks for fast delivery worldwide

Part No.	Top Diameter	Spout Diameter	Material	Pack Quantity
M1023B-100	100mm	11mm	Blue PP	4



See the full metal detectable range on pages 134 to 138

Bailer (316L ss)

Volume 1L to 4L



- Crevice free
- Satin finish
- Flat cut rim on bowl
- 316L Stainless Steel

Part No.	Nominal Volume	Max. Bowl Diameter	Overall Length
A296-1	1L	170mm	285mm
A296-2	2L	215mm	340mm
A296-4	4L	270mm	415mm

Bailer (PP)

Volume 2L



- PP Construction
- Crevice free design
- Smooth finish

Part No.	Nominal Volume	Max. Bowl Diameter	Overall Length
8333P-2	2L	220mm	355mm

See the Products and meet the Team



You are welcome to visit us at our premises in Coleshill.

- Product Training for individuals and small groups
- Help and advice
- See our latest products
- Meet the Sampling Systems team

Sieving Tool



- Ideal for pushing powders through mesh screens
- 316L stainless steel
- Rounded corners
- Crevice free construction
- Satin finish

Part No.	Disc Diameter	Overall Height	Material
A516-120	120mm	160mm	316L stainless steel

Earthing Lugs



- Extra cost option for any stainless steel item such as a scoop, sampler or container etc...
- Provides a convenient connection point for earthing (grounding) wires
- Ideal when working with flammable solvents or in ATEX rated environments
- Earthing lugs can be welded to almost any stainless steel device

Part No.	Description
LUG-1	Earthing Lug - 316L stainless steel

Bowls



Volume 1000ml to 4000ml

- Crevice free design
- Polished finish
- Range of sizes
- 304 Stainless Steel

Part No.	Nominal Volume	Diameter	Height	Material
A534-1000	1000ml	170mm	86mm	304 ss
A534-2000	2000ml	217mm	112mm	304 ss
A534-4000	4000ml	271mm	130mm	304 ss

Stainless Cups



Volume 30ml

Stainless Cups are ideal for use with small amounts of tablets, capsules, granules or powders. The flat base design means they are ideal for weigh scales.

- 304 stainless steel
- Crevice free
- Polished

Part No.	Nominal Volume	Max. Diameter	Height	Material
A764-30	30ml	52mm	25mm	304 ss

Buckets (316Lss)



Volume 10L to 15L

- Made from 316L stainless steel
- Crevice free interior
- Swing handle
- Flat base
- Non graduated



Part No.	Nominal Volume	Top Diameter	Height	Material
A586-10	10L	298mm	233mm	316L ss
A586-12	12L	310mm	262mm	316L ss
A586-15	15L	330mm	305mm	316L ss

Lids

Suitable for use with A586 buckets only

Part No.	To suit Bucket Volume	Material
A586-10L	10L	316L ss
A586-12L	12L	316L ss
A586-15L	15L	316L ss

Buckets (316Lss)



Volume 12L

- Crevice free interior
- Graduated
- Supplied with skirt band
- Robust design
- 316L stainless steel



Part No.	Nominal Volume	Top Diameter	Height	Material
A826-12	12L	310mm	285mm	316L ss

Buckets



Volume 6L to 15L

- Crevice free interior
- Graduated
- Supplied with skirt band
- Robust design
- 304 stainless steel

Part No.	Nominal Volume	Top Diameter	Height	Material
A264-6	6L	280mm	190mm	304 ss
A264-10	10L	300mm	295mm	304 ss
A264-12	12.5L	330mm	315mm	304 ss
A264-15	15L	350mm	360mm	304 ss

Bucket with Spout (316Lss)



Volume 15L to 20L

- Bucket with pouring spout
- Made from 316L stainless steel
- Crevice free interior
- Non graduated
- Swing handle
- Supplied with skirt band



Part No.	Nominal Volume	Overall Diameter	Height	Material
A686-15	15L	310mm	333mm	316L ss
A686-20	20L	330mm	387mm	316L ss

Spoons & Spatulas Disposable & reusable



SteriWare® Sample Spoons

Volume 3ml to 10ml

- Manufactured and packed in a Cleanroom
- Individually Bagged, 100 per Box
- Made from FDA & EU 10/2011 Conforming Materials
- BSE/TSE Free
- Full Batch Traceability
- Available Sterile (gamma irradiated)

See pages 18-21 for the full range

Part No.	Nominal Volume	Colour	Sterile	Material
8088A-03	3ml	White	No	PS
8088A-03S	3ml	White	Yes	PS
8088A-10	10ml	White	No	PS
8088A-10S	10ml	White	Yes	PS
8088B-10	10ml	Blue	No	PP
8088B-10S	10ml	Blue	Yes	PP
8088R-10S	10ml	Red	Yes	PS



SteriWare® Micro-Spatulas

Volume 0.3ml to 2ml

- Manufactured and packed in a Cleanroom
- Individually Bagged, 100 per Box
- Made from FDA & EU 10/2011 Conforming Materials
- BSE/TSE Free
- Full Batch Traceability
- Available Sterile (gamma irradiated)

See page 23 for the full range

Part No.	Nominal Volume	Sterile	Blade Width x Length
8015V-170	0.3ml	No	4 x 40mm
8015V-170S	0.3ml	Yes	4 x 40mm
8015N-170	0.5ml	No	6 x 40mm
8015N-170S	0.5ml	Yes	6 x 40mm
8015A-170	2ml	No	13 x 40mm
8015A-170S	2ml	Yes	13 x 40mm



Stainless Spoons (304 or 316L ss)

Volume 2ml to 10ml



- Available in both 304 and 316L stainless steel
- Crevice free
- Bowl & flat ends
- Bright Polish

Part No.	Nominal Bowl Volume	Nominal Overall Length	Material
A506-300	10ml	300mm	316L ss
A506-600	10ml	600mm	316L ss
A506-1000	10ml	1000mm	316L ss
A504-1	2ml	155mm	304 ss
A504-2	10ml	210mm	304 ss
A504-3	2ml	300mm	304 ss
A504-4	10ml	305mm	304 ss
A504-5	10ml	500mm	304 ss

Laboratory Spoon

Volume 2ml to 12ml



- Crevice free construction
- Made from 304 stainless steel

Part No.	Nominal Volume	Length	Material
A611-150	2ml	150mm	304 ss
A611-210	3ml	212mm	304 ss
A611-250	6ml	253mm	304 ss
A611-300	12ml	303mm	304 ss

New

Accessories

Double Ended Laboratory Spoon

Volume 1ml to 12ml



- Double ended stainless steel spoon (different volume at each end)
- Flat handle
- Crevice free construction
- Made from 304 stainless steel

Part No.	Nominal Volumes	Length	Material
A612-150	1ml & 2ml	150mm	304 ss
A612-210	1ml & 3ml	212mm	304 ss
A612-250	4ml & 7ml	253mm	304 ss
A612-300	7ml & 12ml	301mm	304 ss

New

Double Ended Spoon

Volume 0.5ml to 8ml



- Double ended stainless steel spoon (different volume at each end)
- Round handle
- Crevice free construction
- Made from stainless steel

Part No.	Nominal Volumes	Length	Material
A104-150	0.5ml & 2ml	150mm	Stainless steel
A104-180	0.8ml & 2.8ml	180mm	Stainless steel
A104-210	1.6ml & 3ml	210mm	Stainless steel
A104-250	1.8ml & 5ml	250mm	Stainless steel
A104-300	2ml & 8ml	300mm	Stainless steel

New

Micro Spoon



- Ergonomic spoon
- Crevice free construction
- Made from 304 stainless steel



Part No.	Length	Bowl Width	Material
A634-150	150mm	5mm	304 ss
A634-200	210mm	5mm	304 ss

Open Spoon



- Single ended stainless steel spoon
- Pouring lip on end of bowl
- Crevice free construction
- Made from 304 stainless steel



Part No.	Length	Max. Width	Material
A620-200	201mm	25mm	304 ss

Chemical Spoon



Volume 5ml to 35ml

- Single bowl
- Flat handle
- Crevice free construction
- Made from 304 stainless steel



Part No.	Length	Nominal Volume	Material
A625-150	150mm	5ml	304 ss
A625-200	200mm	10ml	304 ss
A625-280	280mm	25ml	304 ss
A625-320	317mm	35ml	304 ss

Pro Whisk Stainless Steel



The stainless steel Pro Whisks are ideal for mixing liquids and creams. They come in a wide variety of sizes from 280mm to 550mm long. The whisks have an additional loop design that makes the mixing action more efficient.

A hook on the end allows them to be hung up after use.



Part No.	Length	Maximum Width	Material
A134-280	280mm	70mm	Stainless Steel
A134-350	350mm	85mm	Stainless Steel
A134-450	450mm	100mm	Stainless Steel



Dosing and Volumetric Spoon

Volume 1.25ml to 100ml



Dosing and Volumetric Spoons are ideal for measuring powders and liquids. The range is available in a variety of sizes 1.25ml, 5ml, 15ml, 20ml and 100ml. The 5ml spoon is the same size as 1 teaspoon.

The spoons are made from high quality 304 stainless steel which means they have good chemical resistance.

Part No.	Volume	Bowl Diameter	Overall Length	Material
A335-012	1.25ml	23mm	108mm	304 ss
A335-050	5ml	33mm	112mm	304 ss
A335-150	15ml	47mm	119mm	304 ss
A335-200	20ml	51mm	141mm	304 ss
A335-1000	100ml	79mm	127mm	304 ss

Volumetric Spoon Set

Volume 1.25ml to 100ml



- Crevice free
- Satin finish
- Supplied as a set
- Each spoon is engraved with volume

Part No.	Volume	Bowl Diameter	Overall Length	Material
A335-1	1.25ml	23mm	107mm	304 ss
	5ml	33mm	112mm	
	15ml	46mm	118mm	
	100ml	79mm	127mm	

Note: Volumetric Spoons are not certified measuring devices

Measuring Scoop (316Lss)

Volume 1ml to 50ml



Accurately Measure Powders with our high quality Stainless Steel Measuring Scoops

The Sampling Systems Measuring Scoop is ideal for scooping fixed volumes of powder and liquid. These Measuring Scoops are made from high quality 316L stainless steel. The scoop bowls are accurately machined from solid stainless steel so there are no unhygienic crevices. Measuring Scoops are highly polished and are available in a range of sizes.

Part No.	Volume	Length	Scoop Diameter	Material
1900A-01	1ml	155mm	10mm	316L ss
1900A-03	3ml	163mm	18mm	316L ss
1900A-05	5ml	155mm	18mm	316L ss
1900A-10	10ml	162mm	25mm	316L ss
1900A-25	25ml	185mm	40mm	316L ss
1900A-50	50ml	170mm	40mm	316L ss

Accessories

Micro-Spatulas (304 & 316L ss)



- 304 or 316L stainless steel
- Range of sizes
- Crevice free
- Bright polish finish

Part No.	Blade Width	Blade Length	Overall Length	Material
A100-1	9mm	50mm	210mm	Stainless steel
A100-2	5mm	45mm	210mm	Stainless steel
A100-3	2.5mm	35mm	150mm	Stainless steel
*A100-20	12mm	40mm	175mm	304 ss
*A106-20	12mm	40mm	173mm	316L ss



Trulla Spatula



- Special curved spatula
- Crevice free construction
- Made from 304 stainless steel

Part No.	Length	Max. Width of Ends	Material
A614-175	177mm	23mm	304 ss

Nuffield Spatula



- Ergonomic spatula
- Crevice free construction
- Made from 304 stainless steel

Part No.	Length	Max. Width of Ends	Material
A615-140	147mm	13mm	304 ss

Curved Spatula



- Double ended spatula
- Crevice free construction
- Made from 304 stainless steel

Part No.	Length	Blade Width	Material
A630-120	120mm	15mm	304 ss
A630-210	210mm	25mm	304 ss

SteriWare Micro-Spatula

Volume 0.3ml to 2ml



- Manufactured and packed in a Cleanroom
- Individually Bagged, 100 per Box
- Made from FDA & EU 10/2011 Conforming Materials
- BSE/TSE Free
- Full Batch Traceability
- Available Sterile (gamma irradiated)

Part No.	Nominal Volume	Sterile	Blade Width x Length	Box Quantity
8015V-170	0.3ml	No	4 x 40mm	100
8015V-170S	0.3ml	Yes	4 x 40mm	100
8015N-170	0.5ml	No	6 x 40mm	100
8015N-170S	0.5ml	Yes	6 x 40mm	100
8015A-170	2ml	No	13 x 40mm	100
8015A-170S	2ml	Yes	13 x 40mm	100

See the full range of SteriWare products at www.sampling.com

Download full product information @ www.sampling.com

Chattaway Spatula



- Ergonomic spatula
- Crevice free construction
- Made from 304 stainless steel

Part No.	Length	Max. Width	Material
A627-100	100mm	9mm	304 ss
A627-150	153mm	9mm	304 ss
A627-210	212mm	9mm	304 ss
A627-250	250mm	10mm	304 ss
A627-300	303mm	10mm	304 ss

Micro Chattaway Spatula



- Ergonomic spatula
- Crevice free construction
- Made from 304 stainless steel

Part No.	Length	Max. Width	Material
A628-100	103mm	4mm	304 ss
A628-150	150mm	4mm	304 ss
A628-200	200mm	4mm	304 ss

Narrow Spoon Spatula



- Ergonomic spatula
- Crevice free construction
- Made from 304 stainless steel

Part No.	Length	Nominal Volume	Material
A618-235	235mm	2ml	304 ss

Flat Spatula



- Ergonomic spatula
- Crevice free construction
- Made from 304 stainless steel

Part No.	Length	Max. Width	Material
A631-120	120mm	21mm	304 ss
A631-210	210mm	25mm	304 ss

Flat Laboratory Spatula



- Double ended stainless steel flat spatula
- Crevice free construction
- Made from 304 stainless steel

Part No.	Length	Max. Width	Material
A613-150	149mm	20mm	304 ss
A613-210	212mm	25mm	304 ss
A611-250	255mm	32mm	304 ss
A611-300	306mm	40mm	304 ss

JUGS Disposable & reusable



SteriWare® Jugs (Graduated)

Volume 500ml to 1000ml

Our graduated measuring jugs are made and packed in a Cleanroom. These ergonomically designed jugs can be used straight from the bag.

- Graduation marks
- Individually Bagged
- FDA, EC 1935/2004 & EU 10/2011 conforming materials
- BSE/TSE Free
- Full Batch Traceability
- Available Sterile (gamma irradiated)
- Cleanroom produced and packed



Part No.	Nominal Volume	Sterile	Top Diameter	Height	Material	Box Quantity
8432P-500	500ml	No	90mm	130mm	PP	35
8432P-500S	500ml	Yes	90mm	130mm	PP	35
8432P-1000	1000ml	No	120mm	170mm	PP	18
8432P-1000S	1000ml	Yes	120mm	170mm	PP	18

SteriWare® Jugs (Non Graduated)

Volume 2000ml

Disposable Jugs have a wide base which makes them very stable. The handle is rounded to make it comfortable to hold.

These jugs are non-graduated.

- Individually Bagged
- FDA & EU 10/2011 Conforming Materials
- BSE/TSE Free
- Full Batch Traceability
- Available Sterile (gamma irradiated)



Part No.	Nominal Volume	Sterile	Diameter	Height	Material	Box Quantity
8049H-2000	2000ml	No	129mm	167mm	HDPE	20
8049H-2000S	2000ml	Yes	129mm	167mm	HDPE	16

Stainless Jugs

Volume 500ml to 5000ml

- Straight sided jugs with side handles
- 304 or 316L stainless steel construction
- Most sizes are graduated



Part No.	Stainless Steel	Nominal Volume	Graduated	Top Diameter	Height
A204-500	304	500ml	Yes	75mm	132mm
A204-1000	304	1000ml	Yes	97mm	157mm
A204-2000	304	2000ml	Yes	129mm	172mm
A204-3000	304	3000ml	No	120mm	235mm
A204-5000	304	5000ml	No	140mm	265mm
A406-500	316L	500ml	Yes	87mm	122mm
A406-1000	316L	1000ml	Yes	105mm	161mm
A406-2000	316L	2000ml	Yes	150mm	171mm
A406-3000	316L	3000ml	Yes	147mm	223mm
A406-5000	316L	5000ml	Yes	178mm	245mm

Conical Jugs

Volume 500ml to 2000ml

- Made from 304 stainless steel
- Crevice free design
- Polished finish
- Graduated



Part No.	Stainless Steel	Nominal Volume	Graduated	Top Diameter	Height
A154-500	304	500ml	Yes	115mm	115mm
A154-1000	304	1000ml	Yes	150mm	140mm
A154-2000	304	2000ml	Yes	171mm	200mm

Metal Detectable Jug

Volume 500ml to 1000ml

- Manufactured and packed in a Cleanroom
- Individually Bagged
- Made from FDA, EC 1935/2004 & food grade EU 10/2011 conforming PP
- BSE/TSE Free
- Full Batch Traceability
- Graduations are on the outside of the jug



Part No.	Nominal Volume	Material	Quantity per Pack
M1044B-500	500ml	Blue PP	4
M1044B-1000	1000ml	Blue PP	4

See the full range of Metal Detectable products on pages 134 to 138

Instrument Trays



The Sampling Systems range of stainless steel trays are ideal for carrying tools etc.

- Range of sizes
- Available from stock
- Crevice free design
- High quality polished finish

Part No.	Dimensions (L x W x H)	Material
A674-215	215 x 160 x 18mm	304 ss
A674-295	295 x 197 x 18mm	304 ss
A674-395	395 x 275 x 11mm	304 ss
A674-490	490 x 320 x 15mm	304 ss

Stainless Trays - General Purpose



The general purpose range of trays are ideal for everything from mixing formulations to carrying waste.

- Range of sizes
- Available from stock
- Crevice free design
- High quality polished finish
- Durable



Part No.	Dimensions (L x W x H)	Nominal Volume	Material
A684-223	223 x 155 x 43mm	950ml	304 ss
A684-240	240 x 160 x 50mm	1200ml	304 ss
A684-310	310 x 197 x 47mm	1500ml	304 ss
A684-340	340 x 210 x 62mm	3000ml	304 ss

Tablet Counting Triangle

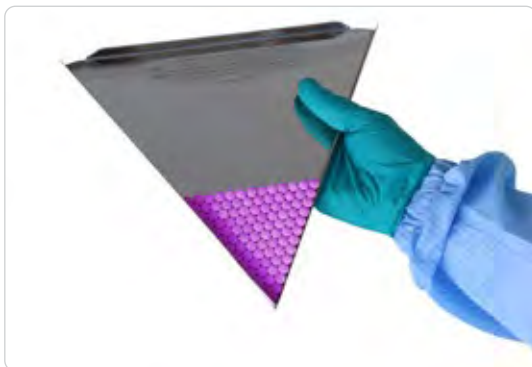

Re-usable

- Quick and easy way to count round tablets
- Suitable for all sizes of round tablets
- 316L stainless steel or Plastic
- Smooth finish
- Easily used by right handed and left handed people
- Etched with a guide to show the number of tablets in the tray

Part No.	Side length	Height	Sterile	Material	Quantity per Pack
A356-160	160mm	14mm	No	316L ss	1
A356-275	275mm	12mm	No	316L ss	1



Single use, Disposable

- Individually bagged
- Sterilised by irradiation
- Manufactured and packed in a Cleanroom
- FDA, EC 1935/2004 & EU 10/2011 Conforming Materials
- BSE/TSE Free
- Full Batch Traceability

Part No.	Side length	Height	Sterile	Material	Box Quantity
8066A-1	230mm	13mm	No	PS	30
8066S-1S	230mm	13mm	Yes	PS	30



316L Stainless Steel Trays



These high quality trays have a deep profile which makes it harder to spill the product. They can be used for many functions including manufacturing, laboratory work and general purpose use.

The trays have easy to clean rounded corners and are designed to be stackable.

- Manufactured from corrosion resistant 316L stainless steel
- Crevice free construction
- Stackable
- Easy to clean bright polish finish (Ra < 0.5)
- BSE/TSE free

Part No.	Dimensions (L x W x H)	Nominal Volume	Material
A236-250	252 x 177 x 45mm	1.5L	316L ss
A236-350	380 x 280 x 54mm	4L	316L ss
A236-400	434 x 327 x 66mm	7L	316L ss
A236-500	535 x 330 x 95mm	14L	316L ss

SteriWare® Tray



The disposable SteriWare® Tray is ideal for hygienic applications within hospitals and in the manufacture of pharmaceutical products.

- Manufactured and packed in a Cleanroom
- Individually Bagged
- Made from Polypropylene (PP) - FDA, EC 1935/2004 & EU 10/2011 conforming grade
- BSE/TSE Free
- Full Batch Traceability
- Available Sterile (gamma irradiated)

Part No.	Dimensions (L x W x H)	Nominal Volume	Sterile	Box Quantity
8081P-3000	318 x 267 x 55mm	3000ml	No	40
8081P-3000S	318 x 267 x 55mm	3000ml	Yes	30

Accessories

Test Tube Rack



Test Tube Racks are made from corrosion resistant stainless steel. They are ideal for use in laboratories and production areas.

The racks are finished to a mirror polish and can be easily cleaned. The stainless steel design means they are ideal for GMP applications.

- All stainless steel construction
- 2 sizes available

Part No.	Capacity	Length	Width	Hole Diameter	Material
A645-12	12 Test Tubes	152mm	58mm	19mm	Stainless steel
A645-48	48 Test Tubes	302mm	100mm	19mm	Stainless steel

Stainless Stirring Paddles



- 316L stainless steel
- Crevice free construction
- Satin finish
- Now available with holes for improved stirring

Part No.	Overall Length	Blade Width	Blade Length	Blade Type
A344-1000	1000mm	125mm	240mm	Plain
A344-1500	1500mm	150mm	300mm	Plain
A916-1000	1000mm	125mm	240mm	With Holes
A916-1500	1500mm	150mm	300mm	With Holes



Hand Paddle With Holes



The Hand Paddle is ideal for stirring and mixing liquids in a tank or vat. The short handle means it is easy to use with either one or two hands. The holes give an easier mixing action.

The paddle is made from robust, chemically resistant, food grade polypropylene (PP).

- Holes in blade
- Made from Food Grade Polypropylene (PP)
- Good chemical resistance
- Hygienic one piece design

Part No.	Blade Width	Length	Material	Colour
8026P-540	133mm	540mm	PP	White



Shovel (316L ss)



Our stainless steel Shovels have a robust strong design. The sturdy handle is fully welded for added strength.

The stainless steel Shovel is designed for medium duty food and pharmaceutical use.

- 316L stainless steel
- Crevice free
- Polished

Part No.	Overall Length	Blade Width	Blade Length	Material
A246-10	1155mm	235mm	350mm	316L ss



Paddles



- Solid blade
- Made from Food Grade Polypropylene (PP)
- Good chemical resistance
- Hygienic one piece design
- Various colours for easy visibility or product dedication

Part No.	Colour	Blade Length	Blade Width	Overall Length
8332P-1	White	290mm	133mm	1200mm
8332R-1	Red	290mm	133mm	1200mm
8332B-1	Blue	290mm	133mm	1200mm

Stirrers



- Holes in blade
- Made from Food Grade Polypropylene (PP)
- Good chemical resistance
- Hygienic one piece design
- Various colours for easy visibility or product dedication

Part No.	Colour	Blade Length	Blade Width	Overall Length
8331P-1	White	290mm	133mm	1200mm
8331R-1	Red	290mm	133mm	1200mm
8331B-1	Blue	290mm	133mm	1200mm

Shovels



- Robust yet lightweight
- Available in two sizes (white only)
- Made from Food Grade Polypropylene (PP)
- Good chemical resistance
- Hygienic one piece design

Part No.	Colour	Head Width	Head Length	Overall Length
8228P-27	White	270mm	330mm	1100mm
8228P-33	White	330mm	370mm	1100mm
8228R-27	Red	270mm	330mm	1100mm
8228B-27	Blue	270mm	330mm	1100mm

Hand Scraper



- Robust yet lightweight
- Made from Food Grade Polypropylene (PP)
- Good chemical resistance
- Hygienic one piece design

Part No.	Colour	Head Width	Overall Length
8336P-1	White	250mm	330mm
8336R-1	Red	250mm	330mm
8336B-1	Blue	250mm	330mm





Stainless Steel Beaker Tongs

A622-310



A621-260

Stainless Steel Beaker Tongs are ideal for picking up beakers, bottles etc. They are made from 304 stainless steel and have the option of a PVC grip. Beaker Tongs can be used to pick up both hot or cold items. They are suitable for production and laboratory work.

Part No.	Description	Length	Material
A621-260	Beaker Tongs	260mm	304 ss
A622-310	Non-slip Beaker Tongs	310mm	304 ss & PVC



Stainless Steel Flask Tongs



The Sampling Systems Flask Tongs are ideal for picking up glass and plastic flasks. The special grip securely fits around the neck of the flask allowing it to be safely lifted. They can be used to pick up hot or cold items. Ideal for production and laboratory work.

Part No.	Length	Material
A623-220	220mm	304 ss



Stainless Steel Tongs



Effortlessly pickup and manoeuvre items with our hygienic tongs. The all 304 stainless steel construction means they are suitable for hygienic applications.

Part No.	Length	Material
A144-160	160mm	304 ss
A144-230	230mm	304 ss
A144-390	390mm	304 ss

Grab-It Swab Holder



- Ideal for holding cloth swabs
- Lightweight aluminium & plastic construction

Part No.	Length	Max. Opening of Jaws
8420A-750	800mm	65mm
8420A-1300	1230mm	65mm

Accessories

Scissors



- Two pointed blades
- Polished finish
- Range of sizes
- 420 stainless steel

Part No.	Overall Length	Blade Length	Material
A364-150	150mm	45mm	420 ss
A364-200	200mm	100mm	420 ss
A364-300	310mm	190mm	420 ss

Rounded Scissors

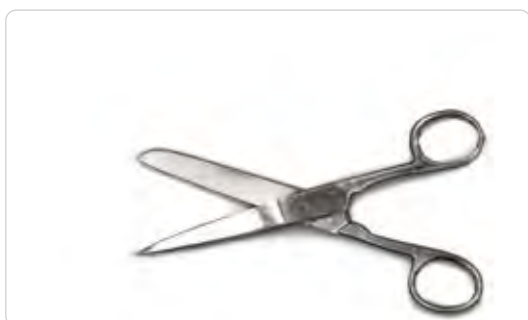

- One rounded blade and one pointed blade
- Polished finish
- 420 stainless steel

Part No.	Overall Length	Blade Length	Material
A555-150	150mm	70mm	420 ss



Double Rounded Scissors



- Two rounded blades
- Polished finish
- Stainless steel

Part No.	Overall Length	Blade Length	Material
A552-150	152mm	55mm	Stainless steel



Website – For the Latest Products

Stay up to date with all our latest products.

www.sampling.com

TWEEZERS, FORCEPS, TONGS Disposable & reusable

SteriWare® Multi-grip Tweezers

SteriWare Multi-grip Tweezers are robust laboratory forceps. They are designed so that they can easily pick up small items and can be used to securely hold vials.

They are made and packed in a cleanroom and are available sterile or non-sterile.

- Individually bagged
- FDA and EU 10/2011 conforming PS
- Cleanroom manufacture and packing
- Available from stock for fast delivery worldwide
- Available sterile (SAL 10⁻⁶) and non-sterile

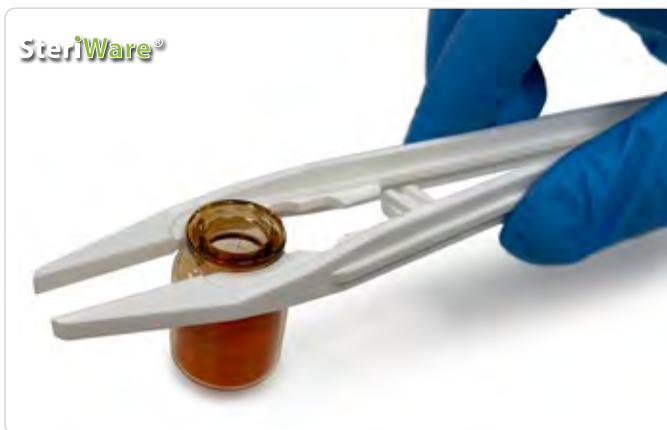

PS (Polystyrene) - WHITE

Part No.	Length	Sterile	Material	Box Quantity
8270A-200	203mm	No	PS	50
8270A-200S	203mm	Yes	PS	50
8270A-300	303mm	No	PS	50
8270A-300S	303mm	Yes	PS	50



SteriWare® Forceps

SteriWare Forceps are manufactured from polystyrene (PS) and are very robust. They are manufactured and packed in a Cleanroom and are available sterile or non-sterile.

SteriWare Forceps are ideal when you are working with small items less than 10mm in size.

- Individually bagged
- FDA and EU 10/2011 conforming materials
- Cleanroom manufacture and packing
- Available from stock for fast delivery worldwide
- Available sterile (SAL 10⁻⁶) and non-sterile



PS (Polystyrene) - WHITE

Part No.	Length	Sterile	Material	Box Quantity
8630A-115	115mm	No	PS	100
8630A-115S	115mm	Yes	PS	100



Straight Forceps (316L ss)



- 316L stainless steel
- Polished finish
- Range of sizes

Part No.	Length	Blade Length	Material
A596-100	100mm	90mm	316L ss
A596-200	200mm	180mm	316L ss
A596-300	300mm	240mm	316L ss
A596-400	405mm	375mm	316L ss

Tweezers (Forceps)



- Polished finish
- Range of sizes
- 304 stainless steel

Part No.	Length	Blade Length	Material
A394-100	100mm	70mm	304 ss
A394-200	200mm	155mm	304 ss
A394-300	300mm	240mm	304 ss
A394-400	405mm	370mm	304 ss



Angled Forceps

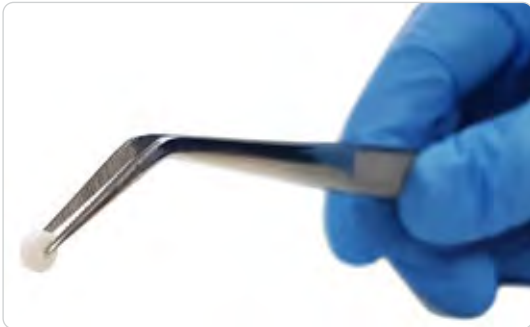

- Curved end
- Polished finish
- Range of sizes
- 316L stainless steel or stainless steel

Part No.	Length	Material
A976-100	104mm	316L ss
A976-200	203mm	316L ss
A976-300	300mm	316L ss



A854-100	105mm	Stainless Steel
A854-150	156mm	Stainless Steel
A854-200	200mm	Stainless Steel



Accessories

Needle



- Available with straight or curved needles
- Crevice free construction
- Made from 304 stainless steel



A638-140



A640-140

Part No.	Needle Type	Overall Length	Needle Length	Material
A638-140	Straight	147mm	40mm	304 ss
A640-140	Curved	145mm	40mm	304 ss



Cleaning Coupons (Reusable)

New sizes

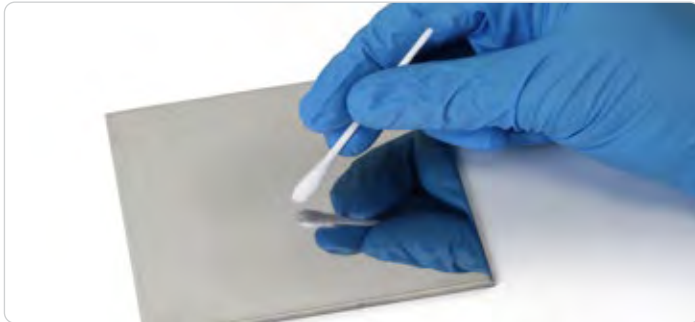

- Test and validate your cleaning regime with our range of Cleaning Coupons
- Available in all popular materials and various sizes
- Custom made coupons available on request

Metal

Part No.	Material	Size
8644AL-50	Aluminium (bright polish)	50 x 50mm
8644AL-100	Aluminium (bright polish)	100 x 100mm
8644S4-50S	304 stainless (satin finish)	50 x 50mm
8644S4-100S	304 stainless (satin finish)	100 x 100mm
8644S4-50B	304 stainless (bright polish)	50 x 50mm
8644S4-100B	304 stainless (bright polish)	100 x 100mm
8644S6-50S	316L stainless (satin finish)	50 x 50mm
8644S6-100S	316L stainless (satin polish)	100 x 100mm
8644S6-50B	316L stainless (bright finish)	50 x 50mm
8644S6-100B	316L stainless (bright polish)	100 x 100mm

Satin finish is similar to 240 grit (Ra < 1 micron).
Bright polish is Ra < 0.2 microns

Non-metal

Part No.	Material	Size
8644AB-50	Borosilicate Glass	50 x 50mm
8644AB-100	Borosilicate Glass	100 x 100mm
8644H-50	HDPE	50 x 50mm
8644H-100	HDPE	100 x 100mm
8644N-50	Nylon	50 x 50mm
8644N-100	Nylon	100 x 100mm
8644PP-50	PP (polypropylene)	50 x 50mm
8644PP-100	PP (polypropylene)	100 x 100mm
8644PVC-50	PVC	50 x 50mm
8644PVC-100	PVC	100 x 100mm
8644SIL-50	Silicone	50 x 50mm
8644SIL-100	Silicone	100 x 100mm
8644T-50	PTFE	50 x 50mm
8644T-100	PTFE	100 x 100mm
8644E-50	EPDM	50 x 50mm
8644E-100	EPDM	100 x 100mm

New



SteriWare® Cleaning Coupons

SteriWare® Cleaning Coupons are manufactured and bagged in a Cleanroom. They are designed to be used straight from the bag and so will help to give a true representation of cleaning protocols.

SteriWare® Cleaning Coupons are available in a range of different polymers and in two sizes.

- Manufactured and packed in a Cleanroom
- Individually Bagged
- Available sterile or non-sterile
- Full Batch Traceability

Part No.	Nominal Dimensions	Material	Sterile	Pack Quantity
8352H-50	50 x 50mm	HDPE	No	50
8352H-50S	50 x 50mm	HDPE	Yes	50
8352H-100	100 x 100mm	HDPE	No	50
8352H-100S	100 x 100mm	HDPE	Yes	50
8352PP-50	50 x 50mm	Polypropylene	No	50
8352PP-50S	50 x 50mm	Polypropylene	Yes	50
8352PP-100	100 x 100mm	Polypropylene	No	50
8352PP-100S	100 x 100mm	Polypropylene	Yes	50
8352PS-50	50 x 50mm	Polystyrene	No	50
8352PS-50S	50 x 50mm	Polystyrene	Yes	50
8352PS-100	100 x 100mm	Polystyrene	No	50
8352PS-100S	100 x 100mm	Polystyrene	Yes	50

Part No.	Nominal Dimensions	Material	Sterile	Pack Quantity
8352N-50	50 x 50mm	Nylon	No	50
8352N-50S	50 x 50mm	Nylon	Yes	50
8352N-100	100 x 100mm	Nylon	No	50
8352N-100S	100 x 100mm	Nylon	Yes	50
8352PVC-50	50 x 50mm	PVC	No	50
8352PVC-50S	50 x 50mm	PVC	Yes	50
8352PVC-100	100 x 100mm	PVC	No	50
8352PVC-100S	100 x 100mm	PVC	Yes	50

Swabbing Kits

High reach swabbing tools



A reproducible swabbing technique is vital to getting meaningful results during Cleaning Validation and environmental swabbing. The operator needs to make sure that a consistent area is swabbed.

Swab Holder Kits - include a Universal Swab Holder attached to a telescopic pole

Swab Kit - includes a Swabbing Template attached to a telescopic pole

Swab Kit (3044B)



- Each Swab Kit contains
- 1 x Telescopic Rod 3m
 - 1 x Elbow connector
 - 1 box Swabbing Templates* (50 per box)

* A choice of two template sizes is available. They are also available sterile or non-sterile.

The single use, plastic template will be in contact with the item being swabbed. In order to minimise the risk of sampling error the Swabbing Templates are made and packed within a Cleanroom.

- Made & Packed in a Cleanroom
- Individually Bagged
- Available sterile or non-sterile
- Full Batch Traceability
- 50 templates per box

Swab Holder Kit (3044C)



- Each Swab Holder Kit contains:
- 1 x Telescopic Rod 3m
 - 1 x Elbow connector
 - 1 x Universal Swab Holder (316L ss)

The Universal Swab Holder is designed to work with most makes of stick swabs and cloth swabs. The Swab Holder is made from hygienic 316L stainless steel.

Note: Swabs are not included with the Swab Holder Kit.



Swabbing Templates can be hand held

Accessories

Swabbing Kits

Part No.	Description
3044B-50	Swab Kit 50 - includes Swabbing Templates 50 x 50mm (50 per box)
3044B-50S	Swab Kit 50S - includes STERILE Swabbing Templates 50 x 50mm (50 per box)
3044B-100	Swab Kit 100 - includes Swabbing Templates 100 x 100mm (50 per box)
3044B-100S	Swab Kit 100S - includes STERILE Swabbing Templates 100 x 100mm (50 per box)
3044C-01	Swab Holder Kit

NOTE: Longer Telescopic Rods are available - ask for details

SPARE SteriWare Swabbing Templates

Part No.	Nominal Hole Dimensions	Material	Sterile	Box Quantity
8888H-50	50 x 50mm	HDPE	No	50
8888H-50S	50 x 50mm	HDPE	Yes	50
8888H-100	100 x 100mm	HDPE	No	50
8888H-100S	100 x 100mm	HDPE	Yes	50



Quick Clip

Quick Clips provide an instant removable seal for use with layflat tubing or bags. Ideal for use in ATEX rated areas where a heat sealer can not be used.

- Seals bags fast
- Water and powder tight
- Range of sizes
- Robust
- Reusable
- Metal detectable option



Part No.	Metal Detectable	Sealing Length	Colour	Material	Pack Quantity
8219A-110	No	110mm	White	Polyamide	100
8219A-150	No	150mm	White	Polyamide	100
8219A-220	No	220mm	White	Polyamide	100
8219M-320	Yes	320mm	Blue	Acetal	10

Sack Clip

Sealing sacks after sampling or dispensing is often tricky and difficult. Our new Sack Clip is a quick, simple and effective way of closing sacks. Simply close sack between the jaws of the Sack Clip.

- Quick and easy to apply
- Quick and easy to remove
- Ratchet mechanism and secondary positive lock for double security
- Robust
- Reusable
- Metal detectable option



Part No.	Metal Detectable	Sealing Length	Colour	Material	Pack Quantity
8010A-1	No	100mm	White	Polyamide	10
8010M-1	Yes	100mm	Blue	Acetal	10

Test Sieves

Robust Sieves for particle size analysis

High Quality test sieves for accurate and efficient particle size analysis.

- Woven wire mesh sieves
- Construction: All 316L stainless steel construction
- Range of aperture sizes available (20 microns to 4mm)
- Certificate of Conformity supplied with each sieve
- Other styles of sieve available on request (Perforated Plate Sieves, Microplate Sieves, Grain sieves etc.)
- Test sieves manufactured to every major International standard (inc. ISO, BSI, & ASTM)



Part No.	Aperture	Body & Mesh Material	Diameter	Height
8700S-01	4mm	316L stainless steel	200mm	50mm
8700S-02	2mm	316L stainless steel	200mm	50mm
8700S-03	1mm	316L stainless steel	200mm	50mm
8700S-04	850 microns	316L stainless steel	200mm	50mm
8700S-05	710 microns	316L stainless steel	200mm	50mm
8700S-06	600 microns	316L stainless steel	200mm	50mm
8700S-07	500 microns	316L stainless steel	200mm	50mm
8700S-08	425 microns	316L stainless steel	200mm	50mm
8700S-09	300 microns	316L stainless steel	200mm	50mm
8700S-10	250 microns	316L stainless steel	200mm	50mm
8700S-11	180 microns	316L stainless steel	200mm	50mm
8700S-12	150 microns	316L stainless steel	200mm	50mm
8700S-13	125 microns	316L stainless steel	200mm	50mm
8700S-14	106 microns	316L stainless steel	200mm	50mm
8700S-15	90 microns	316L stainless steel	200mm	50mm
8700S-16	75 microns	316L stainless steel	200mm	50mm
8700S-17	53 microns	316L stainless steel	200mm	50mm
8700S-18	32 microns	316L stainless steel	200mm	50mm
8700S-19	25 microns	316L stainless steel	200mm	50mm
8700S-20	20 microns	316L stainless steel	200mm	50mm



Test Sieve 200mm diameter mounted on a Sieve Receiver (see below)

Other diameters and mesh sizes are available.

Please ask for details.

Sieve Receiver 316L

Sieve Receivers collect the product that passes through the sieve stack. They are suitable for use with 200mm diameter sieves.

- Made from 316L stainless steel
- Crevice free interior

Part No.	Diameter	Height	Stainless Steel
A736-3000	200mm	100mm	316L



Sampler Storage Cases

These cases are ideal for the safe storage and transportation of samplers and other equipment. They are also ideal for ensuring that your clean samplers remain clean whilst they are being stored or carried around the factory. All cases are supplied with foam inner to protect the samplers.

Standard Sampler Case

- Rugged plastic construction
- Four sliding clasps keep the case shut

Part No.	Internal Dimensions L x W x H
8505A-01	1210 x 225 x 96mm



Superior Sampler Case

- Lockable (2 keys supplied)
- High impact resistant outer
- Metal hinges for a long life
- Very high quality finish

Part No.	Internal Dimensions L x W x H
8500A-01	870 x 285 x 116mm



Aluminium Sampler Case

- Lockable
- Aluminium outer
- Foam lined to protect your samplers
- Strong and robust
- Supplied with a sturdy carrying handle

Part No.	Internal Dimensions L x W x H
8509A-500	490 X 220 X 80mm
8509A-1200	1200 X 220 X 80mm



Mini Case

- Ideal for storing small samplers
- Two clasps keep the case closed

Part No.	Internal Dimensions L x W x H
8505A-12	250 x 175 x 40mm



Jumbo Case

- Rugged plastic construction
- Extends up to 2400mm
- Excellent Value

Part No.	Internal Dimensions L x W x H
8502A-01	1800x140x140mm



Cleaning Brushes

It is essential to ensure that your sampler is properly cleaned. Sampling Systems supply a range of brushes that are ideal for cleaning both stainless steel and plastic samplers.

Use the appropriate diameter and length for your sampler.

- Hygienic nylon bristles
- Robust aluminium handle
- Available in a range of lengths and diameters



Part No.	Description	Overall Length	Min. Tube Diameter	Max. Tube Diameter
8020N-600	Narrow Brush	600mm	7mm	14mm
8020N-1100	Narrow Brush	1100mm	7mm	14mm
8020N-1600	Narrow Brush	1600mm	7mm	14mm
8020N-2100	Narrow Brush	2100mm	7mm	14mm
8020A- 600	Standard	600mm	15mm	30mm
8020A- 1100	Standard	1100mm	15mm	30mm
8020A- 1600	Standard	1600mm	15mm	30mm
8020A- 2100	Standard	2100mm	15mm	30mm
8020J-600	Wide Brush	600mm	30mm	45mm
8020J-1100	Wide Brush	1100mm	30mm	45mm
8020J-1600	Wide Brush	1600mm	30mm	45mm
8020J-2100	Wide Brush	2100mm	30mm	45mm

Temperature Probe



The Temperature Probe is ideal for measuring the temperature of products deep within silos and tanks. The Temperature Probe consists of a robust, lightweight aluminium probe with a clear easy read, battery operated display.

- Clear digital readout in °C or °F
- 2m length, 16mm diameter
- Aluminium probe
- Range: -10 to +50°C (14 to 122°F)
- Supplied with 4 x AA (LR6) batteries

Part No.	Description
K101-2000F	Temperature Probe 2m - Aluminium

Thermometer



The Thermometer is a small, robust, accurate device and is ideal for general laboratory use.

- Hygienic stainless steel probe
- Range: -39.9 to 149.9°C (accurate up to 124.9°C)
- Supplied with traceable certificate of calibration
- Light weight (only 45g)
- Highly accurate
- Housed in high impact ABS plastic case
- Clear display
- Battery Life 3000 hours

Part No.	Length	Probe Diameter	Material	Sensor Type
8702A-1	246mm	3mm	Stainless steel with ABS case	Thermistor

Special Samplers

Cost Effective Custom Design Service



- Sampling Systems has over 30 years of designing and building custom made samplers. Whatever you require please contact us.
- Our in-house designers have a huge library of past designs to work with.
- Latest 3D design software
- 3D printer to build prototypes
- ***Please call to discuss your requirements***



Accessories

Custom Design and Sizes

We have designed samples for virtually every type of product imaginable.

We can make custom versions of our standard samplers. They can be longer, shorter, wider, thinner etc.

Special Materials

Most of our samplers are manufactured from 316L stainless steel. We can also manufacture items from materials such as titanium, PTFE etc.

Special Finishes

Whatever finish you require we can help. Everything from electro-polished, pickled and passivated, mirror polish etc.



Labels

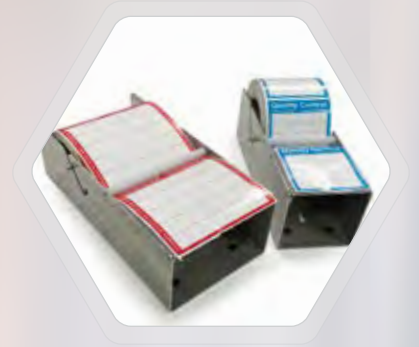



Which type of label is right for me?

Sampling Systems offer two types of standard label backing:

- Ultra Adhesive Labels
- PharmaLabels

1. Ultra Adhesive (UA) Labels

- Robust foil-backed labels
- Standard label are available in two sizes: 95mm x 95mm or 150mm x 150mm
- Very high strength adhesive - will even stick on very dusty surfaces
- Working Temperature Range -20 to +70°C (-5 to +160°F)

Dust Proof



UA Labels are ideal for sealing sacks after sampling. UA Labels will stick to virtually any surface, they will even stick to dusty sacks.

The label will not only record the fact that the sack has been sampled but it will prevent the sack from leaking powder as it is handled.

Weather Proof



Even after being submerged in water for 48 hours the UA label was intact, it was securely attached to the bag and could be written on using a ball point pen.

2. PharmaLabels (with food grade glue)

PharmaLabels are a range of paper labels with a special FDA acceptable adhesive. PharmaLabels are ideal for applications where the adhesive might come into contact with the product.

- Medium strength adhesion
- FDA acceptable adhesive (CFR175.105)
- Working Temperature Range -40 to +70°C (-40 to +160°F)

i *Try before you buy*

Ask for your free sample pack

Quality Control Labels

Quality Control Labels are available printed on either Ultra Adhesive or PharmaLabels.

- Large writing area
- Available in two sizes
- Each roll individually packed
- Available from stock for next day delivery
- Ideal for sealing dusty or split sacks (UA labels)



Part No.	Label Type	Colour	Text	Label Size	Labels per Roll
8220A-01	Ultra Adhesive	Red	Quality Control	95 x 95mm	500
8220P-01	Pharma Label	Red	Quality Control	95 x 95mm	500
8220A-001	Ultra Adhesive	Red	Quality Control	150 x 150mm	250
8220P-001	Pharma Label	Red	Quality Control	150 x 150mm	250

Ultra Adhesive = very strong glue

Pharma Labels = food grade, medium strength glue



Part No.	Label Type	Colour	Text	Label Size	Labels per Roll
8220A-02	Ultra Adhesive	Green	Quality Control	95 x 95mm	500
8220P-02	Pharma Label	Green	Quality Control	95 x 95mm	500
8220A-002	Ultra Adhesive	Green	Quality Control	150 x 150mm	250
8220P-002	Pharma Label	Green	Quality Control	150 x 150mm	250

Ultra Adhesive = very strong glue

Pharma Labels = food grade, medium strength glue



Part No.	Label Type	Colour	Text	Label Size	Labels per Roll
8220A-03	Ultra Adhesive	Yellow	Quality Control	95 x 95mm	500
8220P-03	Pharma Label	Yellow	Quality Control	95 x 95mm	500
8220A-003	Ultra Adhesive	Yellow	Quality Control	150 x 150mm	250
8220P-003	Pharma Label	Yellow	Quality Control	150 x 150mm	250

Ultra Adhesive = very strong glue

Pharma Labels = food grade, medium strength glue



Part No.	Label Type	Colour	Text	Label Size	Labels per Roll
8220A-04	Ultra Adhesive	Blue	Quality Control	95 x 95mm	500
8220P-04	Pharma Label	Blue	Quality Control	95 x 95mm	500
8220A-004	Ultra Adhesive	Blue	Quality Control	150 x 150mm	250
8220P-004	Pharma Label	Blue	Quality Control	150 x 150mm	250

Ultra Adhesive = very strong glue

Pharma Labels = food grade, medium strength glue



Part No.	Label Type	Colour	Text	Label Size	Labels per Roll
8220A-05	Ultra Adhesive	Black	Quality Control	95 x 95mm	500
8220P-05	Pharma Label	Black	Quality Control	95 x 95mm	500
8220A-005	Ultra Adhesive	Black	Quality Control	150 x 150mm	250
8220P-005	Pharma Label	Black	Quality Control	150 x 150mm	250

Ultra Adhesive = very strong glue

Pharma Labels = food grade, medium strength glue



Part No.	Label Type	Colour	Text	Label Size	Labels per Roll
8220A-06	Ultra Adhesive	White	n/a	95 x 95mm	500
8220P-06	Pharma Label	White	n/a	95 x 95mm	500
8220A-006	Ultra Adhesive	White	n/a	150 x 150mm	250
8220P-006	Pharma Label	White	n/a	150 x 150mm	250

Ultra Adhesive = very strong glue

Pharma Labels = food grade, medium strength glue

Process Labels



Process Labels are designed to help prevent errors during the manufacturing process.

- Colour coded for improved recognition by operators
- Printed on Ultra Adhesive (UA) labels
- Each roll individually wrapped
- Available from stock for next day delivery
- Ideal for sealing dusty sacks (UA labels)



Part No.	Label Type	Colour	Text	Label Size	Labels per Roll
8220A-30	Ultra Adhesive	Green	Released	95 x 95mm	500

Ultra Adhesive = very strong glue



Part No.	Label Type	Colour	Text	Label Size	Labels per Roll
8220A-31	Ultra Adhesive	Blue	Sampled	95 x 95mm	500
8220P-31	Pharma Label	Blue	Sampled	95 x 95mm	500
8220P-031	Pharma Label	Blue	Sampled	150 x 150mm	250

Ultra Adhesive = very strong glue

Pharma Labels = food grade, medium strength glue



Part No.	Label Type	Colour	Text	Label Size	Labels per Roll
8220A-32	Ultra Adhesive	Orange	Quarantine	95 x 95mm	500

Ultra Adhesive = very strong glue



Part No.	Label Type	Colour	Text	Label Size	Labels per Roll
8220A-33	Ultra Adhesive	Black	Rejected	95 x 95mm	500

Ultra Adhesive = very strong glue



Part No.	Label Type	Colour	Text	Label Size	Labels per Roll
8220A-34	Ultra Adhesive	Yellow	In-Process	95 x 95mm	500

Ultra Adhesive = very strong glue



Part No.	Label Type	Colour	Text	Label Size	Labels per Roll
8220A-35	Ultra Adhesive	Red	Dispensed	95 x 95mm	500

Ultra Adhesive = very strong glue



Part No.	Label Type	Colour	Text	Label Size	Labels per Roll
8220A-51	Ultra Adhesive	Red / Yellow	Allergen	95 x 95mm	500

Ultra Adhesive = very strong glue



Part No.	Label Type	Colour	Text	Label Size	Labels per Roll
8220A-52	Ultra Adhesive	Red	Dirty	95 x 95mm	500

Ultra Adhesive = very strong glue



Part No.	Label Type	Colour	Text	Label Size	Labels per Roll
8220A-53	Ultra Adhesive	Green	Clean	95 x 95mm	500

Ultra Adhesive = very strong glue



Part No.	Label Type	Colour	Text	Label Size	Labels per Roll
8220A-54	Ultra Adhesive	Blue	Not For Human Use	95 x 95mm	500

Ultra Adhesive = very strong glue

Clear Labels

A see-through label with a food grade adhesive



Clear Labels are ideal for sealing bags and sacks. These labels are made from a clear polypropylene film and they have an FDA acceptable adhesive. Clear Labels are ideal for sealing sampling holes. The label is transparent so that printing underneath the label can still be easily read.

Clear Labels are suitable for some types of NIR. Contact us for a free sample to test.

- Each roll is individually wrapped
- 95mm x 95mm size
- Adhesive conforms to FDA 21 CFR 175.105

Part No.	Label Type	Colour	Size	Number of Labels per Roll
8220C-01	Pharma Labels	Clear	95 x 95mm	500

Pharma Labels = food grade, medium strength glue

Custom Labels



Simply sketch your design on paper and email it to Sampling Systems and we will do the rest.

- Custom labels to your design specification
- Available as PharmaLabels or UA Labels
- Any size or shape of label is possible
- Single colour or full colour printing is available
- Minimum order 5 rolls
- Typical delivery time is 2 weeks
- Contact Sampling Systems for further information

Adhesive Tape

Adhesive Tape for sealing sacks

Adhesive Tape is ideal for sealing holes in sacks and bags. The tape comes in a roll that is 50m long so you just cut off as much as you need.

Adhesive tape is available with either the extra strong Ultra Adhesive or Pharma adhesive (conforms to FDA 21 CFR 175.105)

- Two types of adhesive (Ultra Adhesive or Pharma Adhesive)
- Available in 2 widths - 50mm and 95mm
- Available from stock



Part No.	Adhesive	Tape Colour	Tape Length	Tape Width
8224A-50	Ultra Adhesive (UA)	White	50m (approx.)	50mm
8224A-95	Ultra Adhesive (UA)	White	50m (approx.)	95mm
8224P-50	Pharma Adhesive	White	50m (approx.)	50mm
8224P-95	Pharma Adhesive	White	50m (approx.)	95mm

ID Tape

Helps prevent handling errors

Sampling Systems ID Tape is available in a range of styles. Containers, bags etc. can be easily labelled with highly visible tape. Quickly identify the status of a container to prevent it being used in error.

- Use with standard tape dispensers
- High strength adhesive
- 10 rolls per box

QUARANTINE

RELEASED

SAMPLED

REJECTED



Part No.	Text	Text Colour	Length per Roll	Width	Rolls per Box
8221A-01	Quarantine	Red	66m	50mm	10
8221A-02	Sampled	Red	66m	50mm	10
8221A-03	Released	Red	66m	50mm	10
8221A-04	Rejected	Red	66m	50mm	10

Label Dispensers

Label Dispensers are useful for storing labels and they provide a large flat writing area.

- Made from 316L stainless steel or aluminium
- Robust construction
- Can be used on a desk or wall-mounted
- Non-slip, non-marking feet

New



Desk Top Use

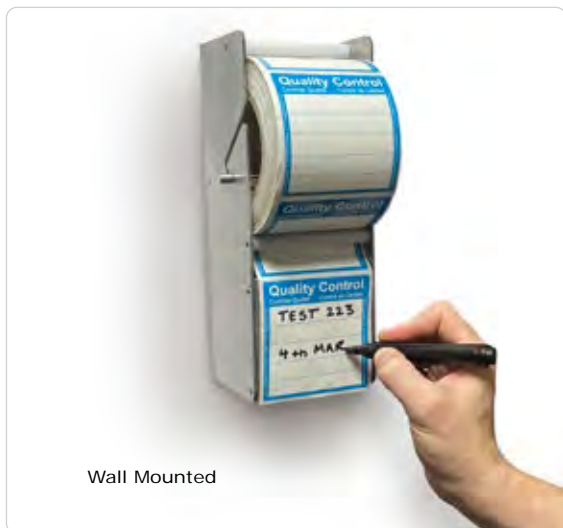

Wall Mounted

Part No.	Max. Label Width	Material
8220X-95	95mm	316L ss
8220X-150	150mm	316L ss
8220Y-95	95mm	Aluminium
8220Y-150	150mm	Aluminium



New

ID Labels

ID Labels are a 2 part tamper-proof label for sealing containers. The labels are ideal for sealing sample containers. The main part of the label is used to seal the sample container and the smaller tear-off part is attached to the sampling record.

Every label has a unique 8 digit reference code and a machine readable barcode (code 128).

Part No.	Colour	Label Size	Number of Labels per Roll
8226A-01	Blue	200 x 25mm	250

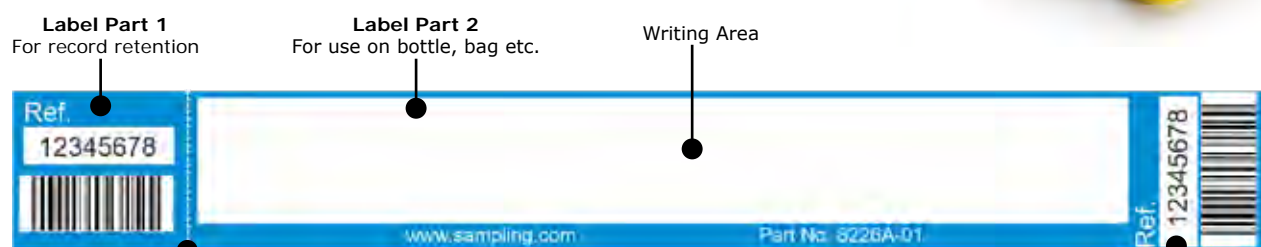

Perforation

Reference No. & Bar Code
Duplicated in Part 1 of the label

Bottles & Containers



Wide Mouth Containers

Volume 30ml to 2000ml



- Popular container for storing and transporting samples
- Suitable for use with powders and liquids
- HDPE Body with PP Lid
- Wide mouth design
- Translucent
- Made from food grade and FDA compliant material
- Certified BSE/TSE free
- Watertight

Part No.	Nominal Volume	Diameter	Height	Quantity Per box
8126H-30	30ml	37mm	63mm	72
8126H-60	60ml	39mm	85mm	72
8126H-125	125ml	51mm	99mm	72
8126H-250	250ml	62mm	131mm	72
8126H-500	500ml	73mm	169mm	48
8126H-1000	1000ml	92mm	201mm	24
8126H-2000	2000ml	120mm	241mm	6

Wide Mouth Amber Bottles

Volume 30ml to 1000ml



- Amber Colour
- Suitable for use with powders and liquids
- HDPE Body with PP Lid
- Wide mouth design
- Watertight

Part No.	Nominal Volume	Diameter	Height	Quantity Per box
8126H-30A	30ml	37mm	63mm	72
8126H-60A	60ml	39mm	85mm	72
8126H-125A	125ml	51mm	99mm	72
8126H-250A	250ml	62mm	131mm	72
8126H-500A	500ml	73mm	169mm	48
8126H-1000A	1000ml	92mm	201mm	24

PP Tubs

Volume 12ml to 1000ml



- General purpose powder container
- Made from polypropylene (PP)
- White
- Crevice free interior

Part No.	Nominal Volume	Diameter
8180A-12	12ml	25mm
8180A-25	25ml	30mm
8180A-60	60ml	41mm
8180A-90	90ml	52mm
8180A-120	120ml	52mm
8180A-250	250ml	76mm
8180A-500	500ml	94mm
8180A-1000	1000ml	113mm

White GMP Tubs

Volume 250ml to 5000ml

New



The Sampling Systems range of polypropylene screw top GMP Tubs is ideal for multiple applications including production, warehouse, sampling and general laboratory work.

GMP Tubs are made in a Cleanroom to ensure cleanliness and purity. A high grade PP resin is used to ensure compliance with the latest FDA, European and food grade standards.

The wide neck means they are ideal for powders and creams. They are splash tight so are suitable for most liquid applications.

- Available from stock in large quantities for immediate delivery.
- Made from chemically resistant, FDA & EU10/2011 acceptable PP
- BSE/TSE free
- Full batch documentation available
- Contact us for bulk discounts

Part No.	Volume	Diameter	Height	Material	Quantity per Pack
8185P-250	250ml	76mm	88mm	PP	100
8185P-500	500ml	94mm	106mm	PP	50

Sample Bottles

Volume 100ml to 1000ml

These sample bottles are made from polyethylene and they have a tamper evident polypropylene cap. The bottles are watertight and so are ideal for use with liquids.

The square shape allows them to pack tightly and they do not roll when placed on a work bench.

- Available from stock in large quantities for immediate delivery
- PE body with PP lid
- Watertight
- Tamper evident cap
- Contact us for bulk discounts



Part No.	Volume	Width	Bottle Height	Internal Neck Diameter
8130A-100	100ml	45mm	108mm	17mm
8130A-250	250ml	60mm	136mm	17mm
8130A-500	500ml	74mm	170mm	17mm
8130A-1000	1000ml	85mm	221mm	17mm

Sample Containers

Volume 50ml to 100ml



- Versatile container
- PP Body with HDPE Lid
- Suitable for Liquid and powders
- Low cost

Note:

- 50ml container is powder-tight & water-tight
- 100ml container is powder-tight only

Part No.	Nominal Volume	Box Quantity
8131A-50	50ml	384
8131A-100	100ml	280

PTFE Pots

Volume 15ml to 2200ml



- Multi purpose containers & cap
- PTFE Body & lid
- Crevice free interior
- Heavy wall construction

Part No.	Nominal Volume	Height	Diameter
A115-15	15ml	34mm	32mm
A115-30	30ml	62mm	32mm
A115-60	60ml	46mm	54mm
A115-120	120ml	62mm	62mm
A115-240	240ml	100mm	66mm
A115-480	480ml	125mm	80mm
A115-1000	1000ml	160mm	101mm
A115-2200	2200ml	260mm	120mm

PTFE Bottles

Volume 1ml to 2000ml



- Multi purpose bottle & cap
- PTFE body & lid
- Crevice free interior
- Heavy wall construction

Part No.	Nominal Volume	Height	Diameter
A125-1	1ml	27mm	16mm
A125-5	5ml	35mm	22mm
A125-10	10ml	50mm	26mm
A125-25	25ml	61mm	33mm
A125-50	50ml	76mm	43mm
A125-100	100ml	88mm	52mm
A125-250	250ml	115mm	67mm
A125-500	500ml	150mm	80mm
A125-1000	1000ml	185mm	100mm
A125-2000	2000ml	240mm	120mm

Aluminium Bottles

Volume 50ml to 1000ml



- Anodised Aluminium body
- PP screw on cap with tamper evident seal
- Watertight



Part No.	Nominal Volume	Bottle Height	Max. Diameter
A179-50	50ml	81mm	40mm
A179-100	100ml	111mm	40mm
A179-250	250ml	153mm	55mm
A179-500	500ml	186mm	75mm
A179-1000	1000ml	240mm	88mm

Carboys

Volume 10L to 20L



The Sampling Systems Carboys are manufactured from heavy duty polypropylene which is not only very tough physically but also has good chemical resistance.

- Available with or without stopcock
- All polymers are FDA compliant and USP Class VI
- Certified BSE/TSE free
- Can be autoclaved

Part No.	Nominal Volume	Stopcock Included	Diameter	Height
8132P-10	10L	No	250mm	390mm
8132P-10T	10L	Yes	250mm	390mm
8132P-20	20L	No	290mm	530mm
8132P-20T	20L	Yes	290mm	530mm

Bottles & Containers

Wide Mouth Square Bottles

Volume 4L



- Polypropylene Body & Cap
- All polymers are FDA compliant Screw-on cap
- Watertight
- Can be Autoclaved
- Supplied as 6 bottles per box

Part No.	Nominal Volume	Height	Width	Box Quantity
8235P-4000	4L	305mm	150mm	6

Sterile Bottles for Liquids and Powders

Volume 60ml to 2000ml



Bottles & Containers

A range of high quality, Wide Mouth Sterile Bottles. The bottles have a body made from HDPE and a screw on cap made from PP. All polymers used for these bottles are made from FDA conforming polymers.

These sterile bottles are ideal for use in laboratories and production areas. The bottles have a wide neck which makes them ideal when working with powders as well as liquids.

The packaging process takes place in a Class 7 Cleanroom and each bottle is packed into a laminate film bag. After packing the bottles are sterilised by gamma irradiation. Simply unwrap and use.

- Powder tight
- Available in a range of sizes
- Packed in a Cleanroom
- Individually Bagged
- FDA Conforming Materials
- BSE/TSE Free
- Available Sterile (gamma irradiated)

HDPE Body & PP Lid

Part No.	Nominal Volume	Diameter	Sterile	Quantity Per box
8404H-60S	60ml	39mm	Yes	50
8404H-125S	125ml	51mm	Yes	50
8404H-250S	250ml	62mm	Yes	50
8404H-500S	500ml	73mm	Yes	30
8404H-1000S	1000ml	92mm	Yes	30
8404H-2000S	2000ml	120mm	Yes	10



SteriWare® Powder Bottles

Volume 250ml to 500ml



Powder Bottles are a premium, single use, screw top bottle from Sampling Systems. They are designed to meet the requirements of the pharmaceutical industry.

The Powder Bottles are made in a Cleanroom to ensure cleanliness. They are all individually bagged.

- Powder tight
- Available in 250ml and 500ml sizes
- Other sizes to follow
- Manufactured, inspected & packed in a Cleanroom
- Individually Bagged
- FDA Conforming Materials
- BSE/TSE Free
- Full Batch Traceability
- Available Sterile (gamma irradiated)



Part No.	Nominal Volume	Sterile	Overall Height	Outer Diameter	Material	Quantity Per box
8890P-250	250ml	No	88mm	76mm	PP	50
8890P-250S	250ml	Yes	88mm	76mm	PP	50
8890P-500	500ml	No	106mm	94mm	PP	37
8890P-500S	500ml	Yes	106mm	94mm	PP	37

Bottles & Containers

Sampling Bags

Non-Sterile Bags

The range of general purpose sampling bags from Sampling Systems are made from clear food grade polyethylene (PE). Suitable for food, chemical and pharmaceutical products.

The bags come with a snap lock closure system along the top

- Supplied in packs of 100
- Made from FDA and EU conforming PE
- Range of #sizes
- Available from stock

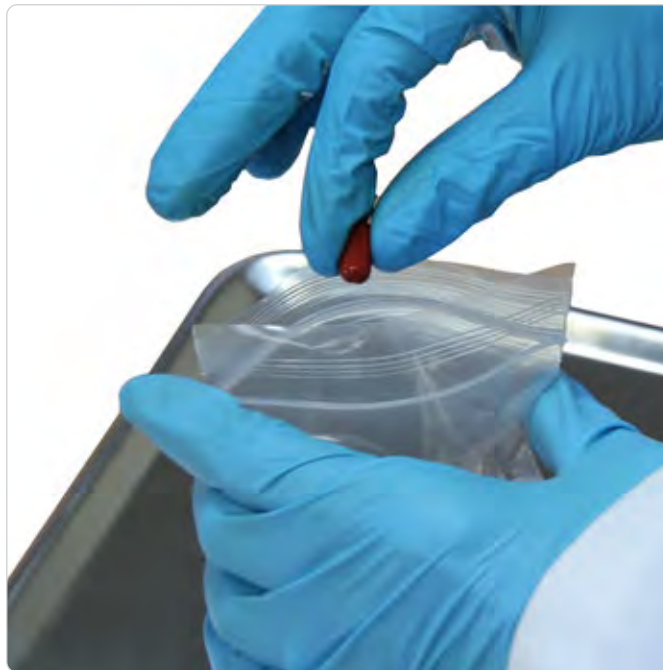

Part No.	Nominal Dimensions	Quantity Per Pack
8246L-100	100 x 140mm	100
8246L-150	150 x 230mm	100
8246L-200	200 x 280mm	100
8246L-250	250 x 350mm	100
8246L-300	330 x 460mm	100

Sterile Bag - Stand Up

Sterile Free-Standing Bags

Volume 400ml to 600ml

The Stand Up range makes transferring samples very easy. The Bags are designed so that they stand up without any additional support.

- Sterile
- Leak-proof with unique metal closure system
- Made from a special super tough grade of PET
- Complies with FDA, USDA and HACCP guidelines
- Pyrogen free
- Suitable up to 80°C
- Available from stock



Part No.	Nominal Volume	Width	Length	Quantity Per box
8079A-450	400ml	102mm	229mm	1000
8079A-600	600ml	152mm	229mm	1000

Sterile Bags

With metal Closure System

Volume 60ml to 10500ml

Our range of sterile bags are an ideal low cost alternative to standard containers. They have a robust metal closure system for easy and secure closing.

- Sterile
- Leak-proof with unique metal closure system
- Made from a special super tough grade of LDPE
- Complies with FDA, USDA and HACCP guidelines
- Pyrogen free
- Suitable up to 80°C
- Wide range of sizes available from stock

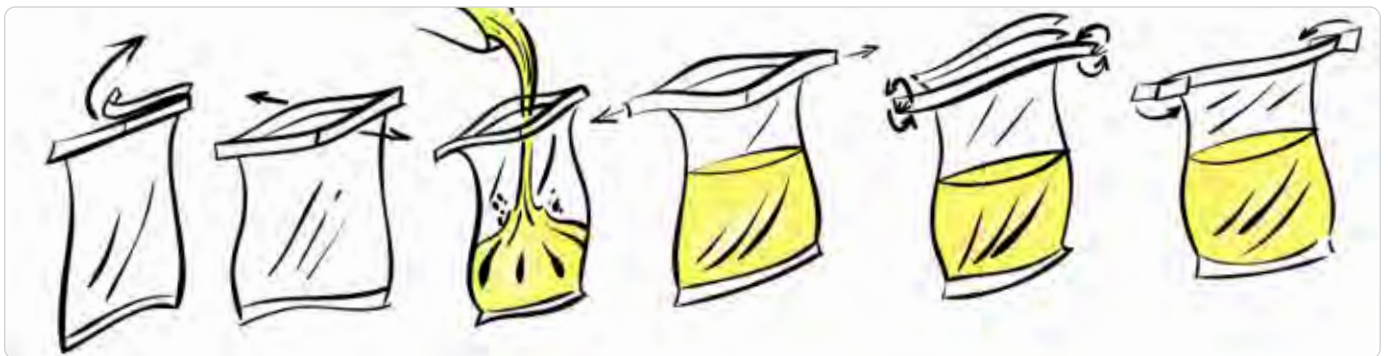

Part No. (plain)	Part No. (with labelling area)	Nominal Volume	Width	Length	Quantity Per box
8080A-60	8080L-60	60ml	76mm	127mm	1000
8080A-150	8080L-150	150ml	76mm	178mm	1000
8080A-450	8080L-450	450ml	114mm	229mm	1000
8080A-900	8080L-900	900ml	114mm	305mm	1000
8080A-1200	8080L-1200	1200ml	114mm	382mm	1000
8080A-5500	N/A	5500ml	305mm	406mm	250
8080A-10500	N/A	10500ml	305mm	610mm	250

Stainless Beakers (316L ss)

Volume 200ml to 3000ml



Stainless Beakers are made from high grade 316L stainless steel. They are available in a range of sizes and have a highly polished, crevice free finish. Stainless Beakers are ideal for use in laboratories or in production environments.

- Multi-purpose containers
- 316L stainless steel
- Not graduated
- Crevice free interior
- Available from stock
- Polished finish (Ra < 0.5 microns)



Part No.	Nominal Volume	Internal Diameter	Height	Stainless Steel
A736-200	200ml	80mm	53mm	316L
A736-500	500ml	82mm	100mm	316L
A736-1000	1000ml	99mm	150mm	316L
A736-2000	2000ml	140mm	155mm	316L
A736-3000	3000ml	203mm	100mm	316L

Beakers With Spouts (316L ss)

Volume 100ml to 5000ml



High quality stainless steel beakers with pouring spouts. The beakers are made from corrosion resistant 316L stainless steel and are graduated.

- Multi-purpose containers
- Graduated
- 316L stainless steel
- Crevice free interior
- Available from stock
- Polished finish (Ra < 0.5 microns)



Part No.	Nominal Volume	Top Diameter	Height	Graduated	Stainless Steel
A866-100	100ml	50mm	60mm	Yes	316L
A866-200	200ml	60mm	75mm	Yes	316L
A866-500	500ml	90mm	120mm	Yes	316L
A866-1000	1000ml	105mm	160mm	Yes	316L
A866-2000	2000ml	150mm	170mm	Yes	316L
A866-3000	3000ml	150mm	220mm	Yes	316L
A866-5000	5000ml	170mm	245mm	Yes	316L

Pots with Lids

Volume 400ml to 5000ml



- 304 stainless steel
- Not graduated
- Crevice free
- Drop-on lid
- Satin finish

Part No.	Nominal Volume	Top Diameter	Height	Stainless Steel
A284-400	400ml	85mm	85mm	304
A284-650	650ml	100mm	100mm	304
A284-1250	1250ml	120mm	120mm	304
A284-2500	2500ml	150mm	150mm	304
A284-5000	5000ml	200mm	200mm	304

Mini-Pots (316L ss)

Volume 5ml to 1000ml



Mini-Pots are high quality containers that are made from 316L stainless steel. Mini-Pots have a crevice free interior and widely used in pharmaceutical and chemical laboratories around the world.

Mini-Pots are available in a wide range of sizes.

- Screw on lid
- Mirror finish
- Multi purpose
- 316L stainless steel
- Crevice free interior
- O-ring available for improved sealing (25ml size upwards)

Part No.	Nominal Volume	Body Diameter	Overall Height	Stainless Steel
A426-5	5ml	17mm	35mm	316L
A426-7	7ml	160mm	45mm	316L
A426-25	25ml	38mm	36mm	316L
A426-50	50ml	50mm	42mm	316L
A426-100	100ml	50mm	683mm	316L
A426-250	250ml	74mm	73mm	316L
A426-500	500ml	100mm	78mm	316L
A426-750	750ml	100mm	116mm	316L
A426-1000	1000ml	100mm	154mm	316L

Accessories XRF Certification - See page 118

O-ring Seals

Mini-Pots can be fitted with silicone O-rings to improve the sealing. The O-rings are made from food grade silicone which conforms to FDA 21 CFR 177.2600.



Part No.	O-ring Description	Material
A426-25S	O-ring for 25ml (A426-25)	Silicone
A426-50S	O-ring for 50ml (A426-50)	Silicone
A426-100S	O-ring for 100ml (A426-100)	Silicone
A426-250S	O-ring for 250ml (A426-250)	Silicone
A426-500S	O-ring for 500ml (A426-500)	Silicone
A426-750S	O-ring for 750ml (A426-750)	Silicone
A426-1000S	O-ring for 1000ml (A426-1000)	Silicone

Jacketed Containers (316L ss)

Volume 3L to 50L

New

Our range of 316L stainless steel Jacketed Containers are ideal for use with temperature sensitive products. The jackets allow heating or cooling liquids to be used so that the product stays at a constant known temperature.

The containers have a jacket with two 1" TC ferrule connectors (BS 4825-3).

Jacketed Containers are made from corrosion resistant 316L stainless steel.

The robust, hygienic design means they are suitable for the most demanding of applications.

- Pharmaceutical grade jacketed containers with lids
- From 3L to 50L (larger sizes on request)
- High quality, heavy duty construction
- Product contact parts 316L stainless steel
- Crevice free interior
- Lid gasket - FDA acceptable silicone rubber
- Fully welded GMP correct construction



Part No.	Nominal Volume	Max. Diameter	Nominal Height	Lid Size (BS 4825-3)	Material (Body & Lid)	Lid Gasket
A746-3	3L	190mm	207mm	4"	316L ss	Silicone - FDA acceptable
A746-5	5L	190mm	313mm	4"	316L ss	Silicone - FDA acceptable
A746-10	10L	240mm	363mm	4"	316L ss	Silicone - FDA acceptable
A746-15	15L	300mm	361mm	4"	316L ss	Silicone - FDA acceptable
A746-25	25L	300mm	533mm	4"	316L ss	Silicone - FDA acceptable
A746-50	50L	400mm	550mm	6"	316L ss	Silicone - FDA acceptable

Safety Cans (316 ss)

Volume 1L to 5L

Safety Cans are designed for use with flammable liquids and solvents. Each Safety Can is fitted with a self closing metering device.

- 316 stainless steel construction
- PTFE gasket
- Satin Finish
- Removable flame trap in the filling-plug
- Pressure control valve in the self-closing metering device (venting at approx. 0.3 bar)
- Ergonomic, highly visible handle (made from powder coated aluminium)

Part No.	Nominal Volume	Body Diameter	Height
A1234-1	1L	111mm	235mm
A1234-2	2L	131mm	291mm
A1234-5	5L	165mm	400mm



Clamp Containers (316L ss)

Volume 1L to 30L

- Multi-purpose, leak-proof containers
- 316L stainless steel
- Crevice free interior
- Supplied with lid, clamp and silicone seal (FDA acceptable grade)
- Wide 4" (100mm) diameter tri-clamp lid BS 4825-3
- Satin finish
- Side handles (excluding 1L size)
- Neck has a 60° angle to promote powder discharge



Part No.	Nominal Volume	Diameter	Height	Side Handles	Lid Size	Material
A566-01	1L	133mm	109mm	No	4"	316L ss
A566-02	2L	130mm	185mm	Yes	4"	316L ss
A566-05	5L	180mm	262mm	Yes	4"	316L ss
A566-10	10L	210mm	366mm	Yes	4"	316L ss
A566-20	20L	300mm	463mm	Yes	4"	316L ss
A566-25	25L	303mm	535mm	Yes	4"	316L ss
A566-30	30L	303mm	602mm	Yes	4"	316L ss
Spares						
K201-4	Spare 4" Silicone Gasket - FDA acceptable grade					Silicone
K202-4	Spare 4" EPDM Gasket - FDA acceptable grade					EPDM
K203-4	Spare 4" Viton Gasket - FDA acceptable grade					Viton
K204-4	Spare 4" PTFE Gasket - FDA acceptable grade					PTFE

Latest Technology

We have well over 1 million parts in stock in our computer controlled warehouse.

Over 95% of the range is available from stock for fast delivery worldwide.

We can deliver to most parts of the world in 2 - 3 days with Europe and North America being a next day service (if the order is received by 1.30pm UK time).



Stainless Containers (316L ss)

316L stainless steel bottles with Tri-ferrule Lids



The Sampling Systems range of Stainless Containers with tri-ferrule fittings are a very popular range for pharmaceutical, chemical and food industries. The high quality finish and 316L stainless steel construction make them ideal for most applications. Our range of Stainless Containers is available with 4 lid sizes.

The Tri-Ferrule lid (BS 4825-3) ensures that the containers are both powder-tight and watertight. The Tri-ferrule system enables the containers to be clamped directly on to other pieces of processing equipment.

The containers can also be electro-polished as an option.

- Multi-purpose containers
- 316L stainless steel body and lid.
- Robust construction
- Crevice free interior
- Tri-ferrule style Lids (BS 4825-3)
- All welds ground and polished
- Complete with lid, silicone gasket (FDA compliant) and clampband
- Fully air-tight and leak-proof

Stainless Containers (1.5" and 2" Lid)

Volume 1ml to 100ml



Part No.	Nominal Volume	Body Diameter	Body Height	Lid Size	Material
A816-1	1ml	48mm	35mm	1.5"	316L ss
A816-2	2ml	48mm	35mm	1.5"	316L ss
A816-5	5ml	48mm	35mm	1.5"	316L ss
A816-10	10ml	48mm	35mm	1.5"	316L ss
A816-25	25ml	48mm	35mm	1.5"	316L ss
A816-50	50ml	48mm	58mm	1.5"	316L ss
A816-100	100ml	64mm	70mm	2"	316L ss

Spares

K201-15	Spare 1.5" Silicone Gasket - FDA acceptable grade
K202-15	Spare 1.5" EPDM Gasket - FDA acceptable grade
K203-15	Spare 1.5" Viton Gasket - FDA acceptable grade
K204-15	Spare 1.5" PTFE Gasket - FDA acceptable grade
K201-2	Spare 2" Silicone Gasket - FDA acceptable grade
K202-2	Spare 2" EPDM Gasket - FDA acceptable grade
K203-2	Spare 2" Viton Gasket - FDA acceptable grade
K204-2	Spare 2" PTFE Gasket - FDA acceptable grade

New

Stainless Containers (2" Lid)

Volume 250ml to 1000ml

Part No.	Nominal Volume	Body Diameter	Height	Lid Size	Material
A836-250	250ml	83mm	97mm	2"	316L ss
A836-500	500ml	83mm	148mm	2"	316L ss
A836-1000	1000ml	102mm	178mm	2"	316L ss
Spares					
K201-2	Spare 2" Silicone Gasket - FDA acceptable grade				
K202-2	Spare 2" EPDM Gasket - FDA acceptable grade				
K203-2	Spare 2" Viton Gasket - FDA acceptable grade				
K204-2	Spare 2" PTFE Gasket - FDA acceptable grade				



Stainless Containers (4" Lid)

Volume 1L to 30L

Part No.	Nominal Volume	Body Diameter	Height	Lid Size	Material
A416-1	1L	102mm	152mm	4"	316L ss
A416-2	2L	122mm	228mm	4"	316L ss
A416-5	5L	162mm	313mm	4"	316L ss
A416-8	8L	212mm	283mm	4"	316L ss
A416-10	10L	212mm	363mm	4"	316L ss
A416-15	15L	272mm	361mm	4"	316L ss
A416-20	20L	272mm	443mm	4"	316L ss
A416-25	25L	302mm	460mm	4"	316L ss
A416-30	30L	302mm	602mm	4"	316L ss
Spares					
K201-4	Spare 4" Silicone Gasket - FDA acceptable grade				
K202-4	Spare 4" EPDM Gasket - FDA acceptable grade				
K203-4	Spare 4" Viton Gasket - FDA acceptable grade				
K204-4	Spare 4" PTFE Gasket - FDA acceptable grade				



Stainless Containers (6" Lid)

Volume 50L to 100L

Part No.	Nominal Volume	Body Diameter	Height	Lid Size	Material
A856-50	50L	400mm	550mm	6"	316L ss
A856-75	75L	450mm	650mm	6"	316L ss
A856-100	100L	500mm	670mm	6"	316L ss
Spares					
K201-6	Spare 6" Silicone Gasket - FDA acceptable grade				
K202-6	Spare 6" EPDM Gasket - FDA acceptable grade				
K203-6	Spare 6" Viton Gasket - FDA acceptable grade				
K204-6	Spare 6" PTFE Gasket - FDA acceptable grade				



Containers with GL45 Threads (316L ss)

Volume 1L to 20L

Our range of GL45 containers have the advantage that the lid can be fully removed for full cleaning. The lid comes with a built in adapter so they will mate with standard GL45 threads.

The containers are available in a variety of sizes and all have a highly polished finish.

- Multi-purpose containers with GL45 lids
- 316L stainless steel body and lid.
- Crevice free interior
- Tri-ferrule style Lids (BS 4825-3)
- All welds ground and polished
- Complete with lid, silicone gasket (FDA compliant) and clampband
- Fully air-tight and leak-proof



External GL45 Thread (with screw on Cap and silicone seal)

Part No.	Nominal Volume	Container Diameter	Container Height
A417-1	1L	102mm	152mm
A417-2	2L	102mm	228mm
A417-5	5L	162mm	313mm
A417-8	8L	212mm	283mm
A417-10	10L	212mm	363mm
A417-15	15L	272mm	361mm
A417-20	20L	272mm	443mm



Internal GL45 Thread (not supplied with a Cap)

Part No.	Nominal Volume	Container Diameter	Container Height
A418-1	1L	102mm	152mm
A418-2	2L	102mm	228mm
A418-5	5L	162mm	313mm
A418-8	8L	212mm	283mm
A418-10	10L	212mm	363mm
A418-15	15L	272mm	361mm
A418-20	20L	272mm	443mm



Stainless Bottle GL45 (316L ss)

Volume 100ml to 1000ml

Stainless Bottles GL45 are made from high quality 316L stainless steel. The bottles have the highly popular GL45 thread which enables them to be easily connected to other items of processing equipment.

Stainless Bottles GL45 are available in three sizes and are electro-polished as standard.

- Multi-purpose containers
- GL45 lid
- Heavy duty construction
- Crevice free interior
- 316L stainless steel construction
- Lid gasket made from PTFE
- Electro-polished



Part No.	Nominal Volume	Container Diameter	Container Height
A886-100	100ml	45mm	89mm
A886-500	500ml	88mm	141mm
A886-1000	1000ml	108mm	175mm



316L Stainless PharmaBottles® (316L ss)

Volume 500ml to 1000ml



Stainless PharmaBottles® are ideal for use with powders and liquids. Each container has a highly polish finish and a watertight screw on lid.

Stainless PharmaBottles® are supplied with an FDA acceptable silicone gasket in the lid.

- Multi purpose containers
- 316L stainless steel body and lid
- Robust construction
- Crevice free interior
- All welds ground and polished
- Complete with screw on lid
- Silicone (FDA acceptable) gasket in lid

Part No.	Nominal Volume	Internal Neck Diameter	Bottle Diameter	Height	Material
A846-500	500ml	48mm	83mm	154mm	316L ss
A846-1000	1000ml	48mm	102mm	178mm	316L ss

Mini-Drums

Volume 1L to 15L

- Multi purpose containers
- Crevice free interior
- Neat recessed fitting lid
- Complete with a swing carrying handle



Toggle Clamps

To secure the lid we recommend the use of toggle clamps

Use 3 toggle clamps per Mini-Drum



O-Ring Seals

- Silicone seal
- FDA grade
- Prices on request

O-rings are also available in Viton and Nitrile - ask for details

Mini-Drums Without Toggle Clamps

Nominal Volume	Height	Internal Diameter	304 stainless steel	316L stainless steel
			Part No.	Part No.
1L	155mm	100mm	A434-1	A446-1
2L	175mm	130mm	A434-2	A446-2
3L	185mm	155mm	A434-3	A446-3
5L	240mm	175mm	A434-5	A446-5
6L	280mm	175mm	A434-6	A446-6
8L	285mm	200mm	A434-8	A446-8
10L	295mm	220mm	A434-10	A446-10
12.5L	285mm	237mm	A434-12	A446-12
15L	285mm	267mm	A434-15	A446-15

Mini-Drums With Toggle Clamps and Silicone Seal

Nominal Volume	Height	Internal Diameter	304 stainless steel	316L stainless steel
			Part No.	Part No.
1L	155mm	100mm	A624-1	A626-1
2L	175mm	130mm	A624-2	A626-2
3L	185mm	155mm	A624-3	A626-3
5L	240mm	175mm	A624-5	A626-5
6L	280mm	175mm	A624-6	A626-6
8L	285mm	200mm	A624-8	A626-8
10L	295mm	220mm	A624-10	A626-10
12.5L	285mm	237mm	A624-12	A626-12
15L	285mm	267mm	A624-15	A626-15

Storage Containers

Volume 20L to 100L

- Multi purpose containers
- Crevice free interior
- Two sturdy handles
- Close fitting recessed lid with handle
- Flat bottom with chime ring to give added protection
- Toggle Clamps and seals are optional extras



Toggle Clamps

Toggle Clamps are used to securely hold the lid. For 20 to 100L containers use 4 toggle clamps

Storage Containers Without Toggle Clamps

Nominal Volume	Height	Diameter	304 stainless steel	316L stainless steel
			Part No.	Part No.
20L	390mm	265mm	A454-20	A466-20
25L	390mm	300mm	A454-25	A466-25
30L	460mm	300mm	A454-30	A466-30
50L	560mm	350mm	A454-50	A466-50
75L	625mm	400mm	A454-75	A466-75
100L	675mm	445mm	A454-100	A466-100

Storage Containers With Toggle Clamps and Silicone Seal

Nominal Volume	Height	Diameter	304 stainless steel	316L stainless steel
			Part No.	Part No.
20L	390mm	265mm	A694-20	A696-20
25L	390mm	300mm	A694-25	A696-25
30L	460mm	300mm	A694-30	A696-30
50L	560mm	350mm	A694-50	A696-50
75L	625mm	400mm	A694-75	A696-75
100L	675mm	445mm	A694-100	A696-100

Toggle Drums (316L ss)

Volume 2L to 300L



The Sampling Systems range of heavy duty Toggle Drums are ideal for storage and production use. These drums are supplied with a fully welded handle, silicone seal (FDA grade) and lid.

The lid is secured by using the pull down latches (toggle clamps).

Toggle Drums are manufactured from 316L stainless steel (body and lid) and have a high quality, polished finish.

- Multi purpose open top drums
- Heavy duty construction
- Crevice free interior
- 316L stainless steel body and lid
- Silicone gasket (FDA acceptable)
- Lid can be completely removed for full cleaning

Bottles & Containers

Part No.	Nominal Volume	Number of Toggles	Internal Diameter	Nominal Height	Material (Body & Lid)
A926-2	2L	2	140mm	160mm	316L ss
A926-5	5L	4	196mm	200mm	316L ss
A926-8	8L	4	196mm	300mm	316L ss
A926-10	10L	4	230mm	270mm	316L ss
A926-15	15L	4	230mm	380mm	316L ss
A926-20	20L	4	300mm	300mm	316L ss
A926-25	25L	4	300mm	380mm	316L ss
A926-30	30L	4	300mm	450mm	316L ss
A926-50	50L	4	395mm	430mm	316L ss
A926-100	100L	6	470mm	610mm	316L ss
A926-200	200L	6	570mm	800mm	316L ss
A926-300	300L	6	710mm	800mm	316L ss

Spares (Drum Lids and Silicone Gaskets)

Internal Diameter of Drum	Drum Lid (316L stainless steel)	Silicone Gasket (FDA acceptable)
196mm	A429-196	A430-196
230mm	A429-230	A430-230
300mm	A429-300	A430-300
395mm	A429-395	A430-395
470mm	A429-470	A430-470
570mm	A429-570	A430-570

Stainless Storage Drums (316L ss)

Volume 1L to 200L



Stainless Storage Drums are a popular part of our range. These drums have a very high quality finish and are supplied with sturdy side handles, lid, gasket and clampband.

The robust, hygienic design means they are suitable for the most demanding of applications.

- Open top pharmaceutical and chemical grade drums with lids
- From 1L to 200L (larger sizes on request)
- High quality, heavy duty construction
- Product contact parts 316L stainless steel
- Crevice free interior
- Lid secured with clampband (304 stainless steel)
- Lid gasket - FDA acceptable silicone rubber
- Hygienic top rim
- Supplied with side handles
- Fully welded GMP correct construction

Part No.	Nominal Volume	Internal Diameter	Nominal Height	Material (Body & Lid)	Lid Gasket
A126-01	1L	140mm	90mm	316L ss	Silicone - FDA acceptable
A126-02	2L	140mm	160mm	316L ss	Silicone - FDA acceptable
A126-03	3L	178mm	150mm	316L ss	Silicone - FDA acceptable
A126-05	5L	196mm	200mm	316L ss	Silicone - FDA acceptable
A126-10	10L	230mm	270mm	316L ss	Silicone - FDA acceptable
A126-15	15L	230mm	380mm	316L ss	Silicone - FDA acceptable
A126-20	20L	300mm	300mm	316L ss	Silicone - FDA acceptable
A126-25	25L	300mm	380mm	316L ss	Silicone - FDA acceptable
A126-30	30L	300mm	450mm	316L ss	Silicone - FDA acceptable
A126-50	50L	394mm	430mm	316L ss	Silicone - FDA acceptable
A126-75	75L	394mm	630mm	316L ss	Silicone - FDA acceptable
A126-100	100L	470mm	610mm	316L ss	Silicone - FDA acceptable
A126-150	150L	570mm	610mm	316L ss	Silicone - FDA acceptable
A126-200	200L	570mm	800mm	316L ss	Silicone - FDA acceptable

Spares

Internal Diameter of Drum	Drum Lid (316L stainless steel)	Silicone Gasket (FDA acceptable)	Drum Clamp
196mm	A429-196	A430-196	A431-196
230mm	A429-230	A430-230	A431-230
300mm	A429-300	A430-300	A431-300
395mm	A429-395	A430-395	A431-395
470mm	A429-470	A430-470	A431-470
570mm	A429-570	A430-570	A431-570

Container with Ferrule (316L ss)

Volume 5L to 200L

These containers are ideal for use with liquids. A hygienic stainless steel drum is fitted with a 1" ferrule (BS4825-3). Containers with Ferrules are the perfect vessel for use in laboratories, production and general work.

The valve (tap) can be clamped on to the ferrule and then be used to empty the container in a controlled manner.

- Manufactured from 316L stainless steel
- Polished
- Robust Construction
- Fitted with a 1" tri ferrule (BS4825-3). Valve can be easily clamped to the container
- Available from stock. Fast delivery worldwide

Note: The tap and accessories are sold separately



A range of optional accessories is available for the containers

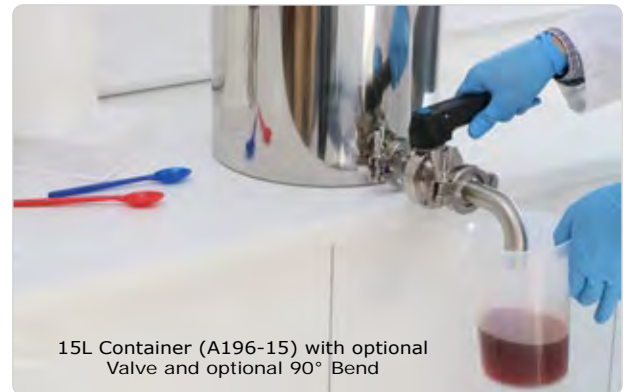

15L Container (A196-15) with optional Valve and optional 90° Bend

Container With 1" Ferrule

Popular Accessories

Part No.	Nominal Volume	Internal Diameter	Nominal Height	Ferrule Size	Material (Body & Lid)	Lid Gasket
A196-05	5L	196mm	200mm	1"	316L ss	Silicone - FDA acceptable
A196-10	10L	230mm	270mm	1"	316L ss	Silicone - FDA acceptable
A196-15	15L	230mm	380mm	1"	316L ss	Silicone - FDA acceptable
A196-20	20L	300mm	310mm	1"	316L ss	Silicone - FDA acceptable
A196-25	25L	300mm	380mm	1"	316L ss	Silicone - FDA acceptable
A196-30	30L	300mm	450mm	1"	316L ss	Silicone - FDA acceptable
A196-50	50L	394mm	431mm	1"	316L ss	Silicone - FDA acceptable
A196-75	75L	394mm	630mm	1"	316L ss	Silicone - FDA acceptable
A196-100	100L	470mm	610mm	1"	316L ss	Silicone - FDA acceptable
A196-150	150L	570mm	610mm	1"	316L ss	Silicone - FDA acceptable
A196-200	200L	570mm	800mm	1"	316L ss	Silicone - FDA acceptable

Options

A136-01S	Valve Kit - Silicone	Kit Includes: 1 x Butterfly Valve 1" with Silicone Seals 1 x Ferrule 1" 2 x Silicone Gasket 1" 2 x Clamp 1"	
A136-01A	Valve Kit - EPDM	Kit Includes: 1 x Butterfly Valve 1" with EPDM Seals 1 x Ferrule 1" 2 x EPDM Gasket 1" 2 x Clamp 1"	
A136-10B	90° Bend	Made from 316L stainless steel	 90° Bend (fits to valve in place of 1" ferrule)

The 90° bend is not included in the valve kits and must be ordered separately.

Containers With Sloping Base - FULL Emptying

Volume 50L to 200L



The Sampling Systems range of drums with a slanted base allow the drums to drain completely. The drums are finished to a mirror polish for easy cleaning. At the bottom of the slanted base is a ferrule for easy emptying.

As standard the stainless steel drums come with lid, clamp and silicone seal. Other seals including Viton and EPDM are available on request.

The drums come with 2 side handles so they can easily moved. The lid clamp can be removed in seconds for easy production and cleaning. All the welds are ground and polished to make them easy to clean.

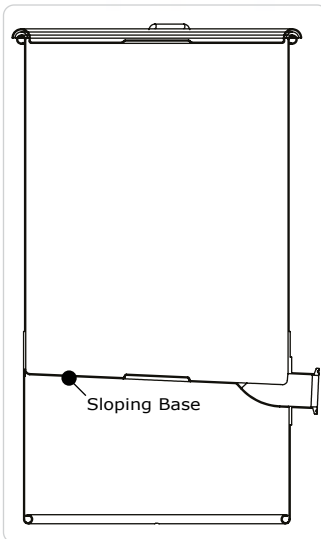

Bottles & Containers

Part No.	Nominal Volume	Internal Diameter	Nominal Height	Ferrule Size	Material (Body & Lid)	Lid Gasket
A616-50	50L	394mm	591mm	1"	316L ss	Silicone - FDA acceptable
A616-100	100L	470mm	787mm	1"	316L ss	Silicone - FDA acceptable
A616-200	200L	570mm	995mm	1"	316L ss	Silicone - FDA acceptable

Options

A136-01S	Valve Kit - Silicone	Kit Includes: 1 x Butterfly Valve 1" with Silicone Seals 1 x Ferrule 1" 2 x Silicone Gasket 1" 2 x Clamp 1"	
A136-01A	Valve Kit - EPDM	Kit Includes: 1 x Butterfly Valve 1" with EPDM Seals 1 x Ferrule 1" 2 x EPDM Gasket 1" 2 x Clamp 1"	
A136-10B	90° Bend	Made from 316L stainless steel	

The 90° bend is not included in the valve kits and must be ordered separately.

Tight Head Drums (316L ss)

Volume 10L to 200L



Tight Head Drums are used throughout the world for handling and storing liquids and oils.

Tight Head Drums are made from hygienic 316L stainless steel. They have a standard 2" bung in the top as well as a second ¾" bung.

- Range of closed top Drums from 10L to 200L
- 316L stainless steel
- Silicone gaskets (FDA acceptable grade)
- Swaged sides for improved strength
- Made from 1.2mm stainless steel
- Not UN certified

Part No.	Nominal Volume	Max. Diameter	Nominal Height	Bung Sizes	Material (Body & Bung)	Bung Gasket
A266-10	10L	260mm	255mm	2" & ¾"	316L ss	Silicone - FDA acceptable
A266-20	20L	289mm	401mm	2" & ¾"	316L ss	Silicone - FDA acceptable
A266-50	50L	362mm	568mm	2" & ¾"	316L ss	Silicone - FDA acceptable
A266-100	100L	458mm	700mm	2" & ¾"	316L ss	Silicone - FDA acceptable
A266-200	200L	581mm	886mm	2" & ¾"	316L ss	Silicone - FDA acceptable

Trolley



Our stainless steel Drums Trolleys are ideal for moving equipment around the factory. These sturdy trolleys have all wheel steering and two of the wheel are fitted with brakes.

- 304 stainless steel frame
- Includes 4 castors (2 lockable)
- Available from stock for fast delivery

Part No.	Max. Diameter Drum	Deck Height
A384-320	320mm	135mm
A384-420	420mm	135mm
A384-500	500mm	135mm
A384-600	600mm	135mm
A384-740	740mm	160mm

sampling.com

Your online reference point



Visit sampling.com for the latest products, news, specification sheets and certification

Glossary and Product Information

Abbreviation	Name	Approximate Working Temperature
EPDM	Ethylene Propylene Diene Monomer	-50°C to +120°C
FEP	Fluorinated Ethylene Propylene	-200°C to +200°C
FKM	Fluoro Elastomer (Viton)	-20°C to +150°C
HDPE	High Density Polyethylene	-50°C to +110°C
LDPE	Low Density Polyethylene	-50°C to +85°C
Nylon	Nylon (see Polyamide)	-20°C to +90°C
PA	Polyamide (see Nylon)	-20°C to +90°C
PC	Polycarbonate	-20°C to +140°C
PP	Polypropylene	-0°C to +130°C
PS	Polystyrene (HIPS - High Impact Polystyrene)	-20°C to +80°C
PTFE	Polytetrafluoroethylene	-200°C to +300°C
PVC	Polyvinyl Chloride	-60°C to +70°C
SI	Silicone	-50°C to +175°C
Viton	Viton™	-20°C to +150°C

- Notes:
- Working temperatures are approximate values only. If you are working near the recommended limit then please contact Sampling Systems to discuss your application.
 - In this brochure PS and HIPS are used interchangeably. HIPS is the type of polystyrene that is used for most SteriWare® products.
 - Viton™ is a registered trademark belonging to The Chemours Company FC, LLC. In this brochure the terms Viton and FKM are used interchangeably.

Important Note:
The information shown on pages 212 and 213 has been given to us by others. This information should be used as a guide only. We strongly recommend that customers carry out their own trials. We do not accept any liabilities for any errors or inaccuracies in the information given.

Information



Can't find what you need?

Call Us for free advice.

We also make specials on request

Chemical Resistance Chart

	Polyethylene (LDPE & HDPE)	Polypropylene (PP)	Polyvinyl Chloride (PVC)	PTFE	Polystyrene (PS)	Silicone Rubber	Viton®	EPDM	Nitrile	316 Stainless Steel (V4A)	304 Stainless Steel (V2A)	Hastelloy C22	Aluminium
Acetaldehyde	3	1	4	1	4	2	4	2	4	1	1	1	2
Acetic Acid (Glacial)	4	1	4	1	4	2	4	2	3	1	3	1	2
Acetic Acid (Dilute)	1	2	4	1	1	1	2	1	3	1	3	1	2
Acetone (Dimethyl Ketone)	4	1	4	1	4	4	4	1	4	1	1	1	1
Aluminium Chloride	2	1	1	1	1	2	1	1	1	2	2	1	4
Ammonia (Liquid)	3	1	1	1	2	?	4	?	3	1	2	2	1
Amyl Acetate	3	2	4	1	4	4	4	1	4	1	1	1	1
Benzene	3	4	3	1	4	4	1	4	4	2	2	2	2
Calcium Hypochlorite	1	1	2	1	1	2	1	1	3	2	3	2	4
Carbon Tetrachloride	4	4	4	1	4	4	1	4	4	2	2	1	4
Chloroform (Trichloromethane)	3	3	4	1	4	4	1	4	4	1	1	1	2
Citric Acid	4	1	2	1	1	1	1	1	1	1	2	1	3
Cod Liver Oil	?	1	1	1	2	2	1	1	1	1	1	1	1
Cupric Acid	2	1	1	1	?	1	1	?	2	2	4	1	4
Cyclohexane	2	4	4	1	2	4	1	4	2	1	1	2	1
Cyclohexanone	4	4	4	1	4	4	4	2	4	1	1	1	1
Diesel	3	1	1	1	2	4	1	4	1	1	1	2	1
Diethylamine	4	1	4	4	?	2	1	3	3	1	1	1	2
Epsom Salts (Magnesium Sulfate)	1	1	1	1	?	1	1	1	1	2	1	2	2
Ethanol (Ethyl alcohol)	1	1	3	1	1	2	1	1	3	1	1	1	2
Ethanolamine	?	4	4	1	?	2	4	2	2	1	1	2	2
Ether (Ethyl Ether)	4	4	4	1	4	4	3	3	4	1	1	2	2
Ethylene Glycol	4	1	1	1	1	4	1	1	1	2	2	1	2
Ethylene Oxide	1	4	4	1	4	4	4	3	4	2	2	1	4
Ferrous Sulfate	1	1	1	1	1	1	1	1	1	2	2	2	2
Formic Acid (Methanoic Acid)	4	1	1	1	2	2	3	2	3	1	2	1	1
Gasoline	3	1	1	2	4	4	1	4	1	1	1	1	4
Hexane	4	2	2	1	4	4	1	4	1	1	1	1	1
Hydrochloric Acid (20%)	1	2	1	1	1	4	1	1	?	4	4	1	4
Hydrochloric Acid (Conc.)	?	2	4	1	2	4	1	1	4	4	4	1	4
Hydrofluoric Acid (20%)	1	1	2	1	4	4	1	1	4	4	4	2	4
Hydrogen Peroxide (10%)	1	1	1	1	1	1	1	1	4	2	2	1	1
Hydrogen Peroxide (90%)	3	2	1	1	2	2	1	1	4	1	2	1	1
Isopropanol (Isopropyl Alcohol)	1	1	1	1	1	1	1	1	?	1	1	?	?
Kerosene	3	2	1	1	2	4	1	4	1	1	1	2	1
Magnesium Chloride	1	1	2	1	?	1	1	1	1	4	4	2	4
Methanol (Methyl alcohol)	1	1	1	1	2	2	1	1	1	1	1	1	1
Methyl Ethyl Ketone	2	2	4	1	4	4	4	1	4	1	1	1	2
Milk	1	2	1	1	1	1	1	1	1	1	1	1	1
Naphtha	1	2	1	2	3	?	4	4	2	1	1	1	2
Nitric Acid (10%)	2	1	1	1	2	3	1	2	4	1	1	1	1
Nitric Acid (Conc.)	3	4	2	1	4	4	1	4	4	1	1	2	4
Nitrobenzene	3	2	4	1	?	4	2	4	4	2	2	4	2
Paraffin	2	1	2	1	2	?	2	1	2	1	1	2	1
Phenol (Carbolic Acid)	4	2	4	1	4	4	1	2	4	2	2	1	1
Phosphoric Acid (Conc)	2	1	2	1	1	4	1	2	4	4	3	1	3
Picric Acid	1	2	4	1	?	4	1	1	3	2	2	2	3
Potassium Chloride	1	1	1	1	1	1	1	1	1	1	2	1	4
Potassium Dichromate	1	1	1	1	?	1	1	1	1	2	2	2	2
Pyridine	2	1	4	1	4	4	4	2	4	1	1	2	2
Sodium Carbonate	2	1	1	1	1	1	1	1	1	1	1	1	4
Sodium Fluoride	1	1	1	1	2	?	1	1	1	4	4	1	2
Sodium Hydroxide (Caustic Soda)	4	1	1	1	2	1	2	1	4	2	3	1	4
Sodium Hypochlorite 20%	1	1	1	1	2	2	1	2	2	3	3	1	4
Starch	2	1	1	1	1	1	1	1	1	1	1	1	1
Sulfuric Acid (10%)	1	1	1	1	1	4	1	2	2	3	4	2	4
Sulfuric Acid (Hot Conc.)	4	4	4	1	4	4	1	4	4	3	4	4	4
Tetrachloroethane	?	3	3	1	?	4	1	4	4	1	2	1	3
Tetrahydrofuran (THF)	3	3	4	1	4	4	4	3	4	1	1	1	?
Toluene (Methylbenzene)	3	3	4	1	4	4	3	4	4	1	1	1	1
Xylene (Dimethylbenzene)	2	2	4	1	4	4	4	4	4	2	2	1	1

Key

1 = Excellent 2 = Good 3 = Fair 4 = Poor, not recommended for prolonged contact ? = No data

Important Notice: Sampling Systems does not accept any responsibility for any errors in this table. It is the responsibility of the end user to carry out their own compatibility tests.

Index by Part Name

Description	Page
Accessory Range	139-178
AccuPod	74-75
Bags	194-195
Bailer	153
Beaker	26, 196
Bottle Adapter	94
Bottle Sampler	101
Bottles	16, 188-193
Bottles & Container Range	187-210
Bowls	17, 154
Brushes	177
Buckets	155
Cake Sampler	50
Capsule Counting Tray	15
Carboy	191
Cases	176
Catch Nets	122
Clamp Containers	199
Cleaning Coupons	30, 172
Cohesive Pocket Sampler	82
Cohesive Sampler	81
Cohesive Slot Sampler	83
Container with Ferrule	208
Container with GL45 Thread	202
Container with Sloping Base	209
Corer	112
Cup Sampler	100
Deep Water Sampler	103, 126
Dippers	104-105, 147
Dipping Bottle	106, 127
Disposable Bailer	108, 124
Disposable Product Range	7-50
Drum Trolley	210
Drums	204-210
Earthing Lugs	88, 154
EnviroDipper	102, 123
Environmental Range	119-132
Flat Spatula	24
Fluid Point Sampler	102
Forceps	25, 170-171
FreeGlide	86-87
Funnels	28-29, 150-152
GL45 Containers	202-203
Grab It	168
Grain Spear	129
Hand Reel & Cables	124
Ice Borer	118
Ice Cream Sampler	116
Ice Sampler	116
Immersion Cylinder	106, 127
ID Label	186
ID Tape	185
Inline Powder Sampler (FreeGlide)	86-87
In-Stream Sampler	103, 126, 147
Jacketed Containers	198
Jugs	27, 162-163
Jumbo Pipette	48
Label Dispenser	186
Labels	180-184
Ladles	47, 146
Liquid Dip Sampler	96
Liquid Master	90-91
Liquid Sampler Range	89-110
LiquiDip	44
LiquiThief	45
Maxi Corer	112
Meat & Cheese Sampler	117
Metal Detectable Range	133-138
Micro Spatulas	22-23
MicroMate	69
MicroThief	68
Mini Corer	112
Mini-Drum	204
Mini-Pot	197
Mono Pocket Sampler	60

Description	Page
Multi Dipper 2	110
MultiThief	73
Needle	171
Paddles	166-167
Pallet Knife	22, 148-149
PeriPump	95
Pharma Bottle	203
PharmaScoops	10-14, 140-144
Pocket Sampler	58-60
Point Sampler	65
Pots with Lids	196
Powder Lance	41, 80
Powder Max	67
Powder Probe	40
Powder Sampler Range	51-88
Powder Trier	57
Powder Thief	39, 52-53
Powered Ice Sampler	117
Pump Sampler	92-93
Quick Clip	174
Sack Clip	174
Sack Sampler	42-43, 62-63
Safety Cans	198
Sample Lance	84, 113
Scissors	169
Scoops - plastic disposable	10-14
Scoops - stainless steel	140-145
Scrapers	24, 148-149
Semi Solid Sampler Range	111-118
Shovel	166-167
Sieving Tool	154
Sleeve Sampler	61
Slot Sampler	32-33, 54-56
Snapper	122
Soil Samplers	130-132
Spatulas	34-38, 156-161
Splitter (Riffler)	132
Spoons	18-21, 156-161
Stainless Beaker	196
Stainless Beaker with Spout	196
Stainless Bottle GL45	203
Stainless Containers	196-210
SteriWare Range	7-50
Stirrer	166-167
Storage Container	205
Storage Drum	207
Sub Sampler Pro	107, 125
Swabbing Kits	31, 173
Swabbing Templates	31, 173
Tablet Counting Triangle	15, 164
Tablet Sampler	85
Tape	185
TeleScoop Pro	98-99, 120-121
Telescopic Sampler	66
Temperature Probe	129, 177
Test Sieves	175
Test Tube Rack	165
Thermometer	177
Thumb Tube	46
Tight Head Drum	210
Tips	60
Toggle Drum	206
Tongs	168
Tray	15, 164-165
Tweezers (Forceps)	25, 170-171
UD Cohesive Sampler	72
UD Master	76-77
UD Sleeve Sampler	71
UD Tablet Maker	78
Utility Dipper	97
V-Spatula	79
ViscoThief	49
Viscous Sampler	114
Water Level Meter	126
Whisk	158

Index by Part Number

Part No.	Page	Part No.	Page	Part No.	Page	Part No.	Page
1030	52-53	8026	166	8921	44	A555	169
1035	61	8045	10-12	9015	22	A566	199
1070	69	8049	27	9045	12	A586	155
1074	68	8050	45	8053	47	A596	171
1095	79	8051	48	9088	19	A606	143
1210	54-56, 128	8053	47	9111	29	A611	157
1213	67	8055	49	9175	22	A612	157
1216	57	8060	39	9286	13	A613	161
1220	58-59	8063	41	9370	28	A614	160
1230	76-78	8064	40	A100	160	A615	160
1290	73	8066	15	A104	157	A616	209
1309	62	8069	32	A105	151	A618	161
1320	63	8073	33	A106	160	A620	158
1360	74-75	8079	194	A115	190	A621	168
1430	60	8080	195	A123	149	A622	168
1500	71	8081	15	A1234	198	A623	168
1610	56	8085	42	A125	190	A624	204
1620	132	8088	19	A126	207	A625	158
1621	130	8095	35	A134	158	A626	204
1622	131	8097	38	A136	208-209	A627	161
1623	131	8111	29	A144	168	A628	161
1624	131	8115	37	A154	163	A630	160
1625	130	8126	188	A164	152	A631	161
1640	65	8130	189	A179	191	A634	158
1660	84, 113	8131	190	A196	208	A638	171
1665	84, 113	8132	191	A200	149	A640	171
1900	64, 159	8175	22	A201	149	A643	145
1942	56, 129	8180	188	A204	163	A645	165
1985	65	8185	189	A236	165	A656	149
2000	72	8209	20	A244	151	A674	164
2015	81	8219	174	A246	166	A684	164
2210	83	8220	180-184, 186	A256	88	A686	155
2220	82	8221	185	A264	155	A694	205
2250	80	8224	185	A266	210	A696	205
3044	31, 173	8226	196	A275	102, 123	A716	150
4000	85	8228	167	A284	196	A736	175, 196
4010	85	8235	191	A296	153	A746	198
5005	104, 147	8240	32	A304	145	A764	154
5020	92-94	8246	194	A314	145	A776	143
5021	93	8270	25	A316	141	A816	200
5030	100	8286	13	A324	146	A826	155
5033	101	8293	20	A326	146	A836	201
5035	90-91	8331	167	A330	149	A846	203
5040	108, 124	8332	167	A333	145	A854	171
5045	110	8333	153	A334	144	A856	201
5055	46	8336	167	A335	159	A866	196
5061	122	8341	14	A336	140	A886	203
5065	98-99, 120-122	8352	30	A344	166	A904	152
5070	124	8360	74-75	A346	142	A916	166
5072	107, 125	8370	28	A350	149	A926	206
5079	103, 126	8404	16	A356	164	A976	171
5085	102, 123	8420	168	A364	169	A996	103, 126, 147
5100	104-105	8432	27	A366	142	K101	129, 177
5132	106, 127	8440	36	A376	142	K102	126
5170	97	8444	15	A384	210	K201	199, 200, 201
5175	96	8500	176	A394	171	K202	199, 200, 201
5224	95	8502	176	A396	142	K203	199, 200, 201
5332	106, 127	8505	176	A406	163	K204	199, 200, 201
5551	102	8509	176	A416	201	LUG	154
6000	116	8570	80	A417	202	M1000	135
6005	118	8601	132	A418	202	M1006	135
6006	116	8630	25	A426	197	M1010	135
6011	117	8640	21	A429	206-207	M1013	137
6015		8642	18	A430	206-207	M1016	138
7000	114	8644	172	A431	207	M1019	138
7008	112	8688	43	A434	204	M1023	136
7009	112	8700	175	A436	144	M1030	136
7010	79, 112	8702	177	A446	204	M1033	137
8008	26	8729	24	A454	205	M1036	136
8010	174	8765	50	A466	205	M1040	135
8015	23	8785	24	A504	157	M1044	137
8017	17	8888	31, 173	A506	157	M1047	137
8020	177	8890	16	A516	154	M1051	136
8022	151	8916	13	A534	154		

Multi-Grip Tweezers

See page 25 for more details.

New

Extra Long

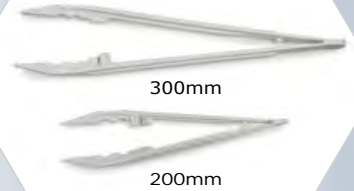

Dual Action



- Cleanroom Manufactured
- FDA/EC compliant PS
- BSE/TSE free
- Sterile option
- 5 year shelf life
- SAL 10⁻⁶

Over 250 NEW Products

📍 **Via Torre, 2**
📍 **28040 Borgo Ticino (NO) - Italy**
☎ **+39 0321 908466**
✉ **customer@exonder.it**
🌐 **<https://www.exonder.it>**



ADDRESS:
Sampling Systems Ltd.
4 & 5 Forge Mills Park,
COLESHILL,
Warwickshire.
B46 1JH
UK

TELEPHONE:
01675 466992 (from UK)
1-888-414-6448 (Toll Free from USA)
+44 (0)1675 466992 (International)

EMAIL:
info@sampling.com

WEB:
www.sampling.com



Sampling Systems Ltd. © 2023

'SteriWare', 'PharmaScoop', 'AccuPod', 'PharmaBottle' and 'FreeGlide' are Trade Marks of Sampling Systems Ltd.

1. All goods are sold subject to our normal Terms and Conditions, contact us for a copy.
2. Sampling Systems operates a process of continual improvement and so we reserve the right to vary specifications at any time.
3. Whilst every effort has been made to ensure the accuracy of the information given in this catalogue, Sampling Systems will not accept any responsibility for any inaccuracies.